

**Safety Regulation Group**



**CAP 413**

**Radiotelephony Manual**

---

**[www.caa.co.uk](http://www.caa.co.uk)**

**Safety Regulation Group**



**CAP 413**

# **Radiotelephony Manual**

**Edition 15**

---

**1 September 2004**

© Civil Aviation Authority 2003

ISBN 0 86039 943 5

First published September 1978

Second edition April 1984

Third edition August 1992

Fourth edition January 1994

Fifth edition January 1995

Sixth edition January 1996

Seventh edition December 1996

Eighth edition January 1998

Ninth edition January 1999

Tenth edition January 2000

Eleventh edition January 2001

Twelfth edition 5 February 2002 (corrected 7 February 2002)

Thirteenth edition 1 October 2002

Fourteenth edition 1 September 2003

Fifteenth edition 1 September 2004

Enquiries regarding the content of this publication should be addressed to:

ATS Standards Department, Safety Regulation Group, Civil Aviation Authority, Aviation House, Gatwick Airport South, West Sussex, RH6 0YR

The latest version of this document is available in electronic format at [www.caa.co.uk](http://www.caa.co.uk), where you may also register for e-mail notification of amendments.

Printed copies and amendment services are available from: Documedia Solutions Ltd, 37 Windsor Street, Cheltenham, Glos., GL52 2DG.



## List of Effective Pages

Chapter	Page	Date	Chapter	Page	Date
	iii	17 December 2004	Chapter 4	3	17 December 2004
	iv	17 December 2004	Chapter 4	4	17 December 2004
	v	17 December 2004	Chapter 4	5	17 December 2004
	vi	17 December 2004	Chapter 4	6	1 September 2004
	vii	17 December 2004	Chapter 4	7	17 December 2004
	viii	17 December 2004	Chapter 4	8	17 December 2004
	ix	17 December 2004	Chapter 4	9	17 December 2004
	x	17 December 2004	Chapter 4	10	17 December 2004
	xi	17 December 2004	Chapter 4	11	17 December 2004
	xii	17 December 2004	Chapter 4	12	17 December 2004
	xiii	1 September 2004	Chapter 4	13	17 December 2004
Chapter 1	1	1 September 2004	Chapter 4	14	17 December 2004
Chapter 1	2	1 September 2004	Chapter 4	15	17 December 2004
Chapter 1	3	1 September 2004	Chapter 4	16	17 December 2004
Chapter 1	4	17 December 2004	Chapter 4	17	17 December 2004
Chapter 1	5	17 December 2004	Chapter 4	18	17 December 2004
Chapter 1	6	17 December 2004	Chapter 4	19	17 December 2004
Chapter 1	7	17 December 2004	Chapter 4	20	17 December 2004
Chapter 1	8	17 December 2004	Chapter 4	21	17 December 2004
Chapter 2	1	1 September 2004	Chapter 4	22	17 December 2004
Chapter 2	2	1 September 2004	Chapter 4	23	17 December 2004
Chapter 2	3	1 September 2004	Chapter 4	24	1 September 2004
Chapter 2	4	1 September 2004	Chapter 4	25	17 December 2004
Chapter 2	5	1 September 2004	Chapter 4	26	17 December 2004
Chapter 2	6	1 September 2004	Chapter 4	27	17 December 2004
Chapter 2	7	1 September 2004	Chapter 4	28	17 December 2004
Chapter 2	8	1 September 2004	Chapter 4	29	17 December 2004
Chapter 2	9	1 September 2004	Chapter 4	30	17 December 2004
Chapter 2	10	1 September 2004	Chapter 4	31	17 December 2004
Chapter 2	11	1 September 2004	Chapter 4	32	17 December 2004
Chapter 2	12	1 September 2004	Chapter 4	33	17 December 2004
Chapter 2	13	1 September 2004	Chapter 4	34	17 December 2004
Chapter 2	14	17 December 2004	Chapter 4	35	17 December 2004
Chapter 2	15	17 December 2004	Chapter 4	36	17 December 2004
Chapter 2	16	17 December 2004	Chapter 4	37	17 December 2004
Chapter 3	1	17 December 2004	Chapter 4	38	17 December 2004
Chapter 3	2	1 September 2004	Chapter 5	1	1 September 2004
Chapter 3	3	1 September 2004	Chapter 5	2	1 September 2004
Chapter 3	4	1 September 2004	Chapter 5	3	17 December 2004
Chapter 3	5	1 September 2004	Chapter 5	4	1 September 2004
Chapter 3	6	17 December 2004	Chapter 5	5	1 September 2004
Chapter 3	7	17 December 2004	Chapter 5	6	1 September 2004
Chapter 4	1	1 September 2004	Chapter 5	7	1 September 2004
Chapter 4	2	1 September 2004	Chapter 5	8	1 September 2004

Chapter	Page	Date	Chapter	Page	Date
Chapter 6	1	1 September 2004	Chapter 10	6	1 September 2004
Chapter 6	2	1 September 2004	Chapter 10	7	1 September 2004
Chapter 6	3	1 September 2004	Chapter 10	8	1 September 2004
Chapter 6	4	1 September 2004	Chapter 10	9	1 September 2004
Chapter 6	5	1 September 2004	Chapter 10	10	1 September 2004
Chapter 6	6	1 September 2004	Chapter 10	11	1 September 2004
Chapter 6	7	1 September 2004	Chapter 10	12	1 September 2004
Chapter 6	8	1 September 2004	Chapter 10	13	1 September 2004
Chapter 6	9	1 September 2004	Chapter 10	14	1 September 2004
Chapter 6	10	17 December 2004	Chapter 10	15	1 September 2004
Chapter 6	11	1 September 2004	Chapter 10	16	1 September 2004
Chapter 6	12	1 September 2004	Chapter 10	17	1 September 2004
Chapter 6	13	1 September 2004	Chapter 10	18	1 September 2004
Chapter 6	14	1 September 2004	Chapter 10	19	1 September 2004
Chapter 6	15	1 September 2004	Chapter 10	20	17 December 2004
Chapter 6	16	1 September 2004	Chapter 10	21	17 December 2004
Chapter 6	17	1 September 2004	Chapter 10	22	17 December 2004
Chapter 6	18	1 September 2004	Chapter 10	23	17 December 2004
Chapter 6	19	1 September 2004	Chapter 10	24	1 September 2004
Chapter 6	20	1 September 2004	Chapter 10	25	17 December 2004
Chapter 6	21	1 September 2004	Chapter 10	26	1 September 2004
Chapter 6	22	1 September 2004	Chapter 10	27	1 September 2004
Chapter 6	23	1 September 2004	Chapter 10	28	1 September 2004
Chapter 6	24	1 September 2004	Chapter 10	29	1 September 2004
Chapter 6	25	1 September 2004	Chapter 10	30	1 September 2004
Chapter 7	1	1 September 2004	Chapter 10	31	1 September 2004
Chapter 7	2	1 September 2004	Chapter 10	32	1 September 2004
Chapter 7	3	1 September 2004	Chapter 10	33	1 September 2004
Chapter 7	4	17 December 2004	Chapter 10	34	1 September 2004
Chapter 7	5	17 December 2004	Chapter 10	35	17 December 2004
Chapter 8	1	1 September 2004	Chapter 10	36	1 September 2004
Chapter 8	2	17 December 2004	Chapter 10	37	1 September 2004
Chapter 8	3	1 September 2004	Chapter 10	38	1 September 2004
Chapter 8	4	1 September 2004	Appendix 1	1	17 December 2004
Chapter 8	5	17 December 2004	Appendix 1	2	17 December 2004
Chapter 8	6	1 September 2004	Bibliography	1	1 September 2004
Chapter 9	1	17 December 2004	Index	1	17 December 2004
Chapter 9	2	17 December 2004	Index	2	17 December 2004
Chapter 9	3	17 December 2004	Index	3	17 December 2004
Chapter 9	4	17 December 2004	Index	4	17 December 2004
Chapter 9	5	17 December 2004	Index	5	17 December 2004
Chapter 10	1	1 September 2004	Index	6	17 December 2004
Chapter 10	2	1 September 2004	Index	7	17 December 2004
Chapter 10	3	1 September 2004			
Chapter 10	4	1 September 2004			
Chapter 10	5	1 September 2004			

# Contents

	<b>List of Effective Pages</b>	iii
	<b>Revision History</b>	x
	<b>Foreword</b>	xii
	Document Description	xii
	Document Purpose	xii
	Document Applicability	xii
	Document Source	xii
	Document Format	xii
	Document Revisions	xiii
	Document Availability	xiii
	Document Comments and Queries	xiii
<b>Chapter 1</b>	<b>Glossary</b>	
	Terms	1
	Definitions	1
	Abbreviations	4
<b>Chapter 2</b>	<b>Radiotelephony</b>	
	General Procedures	1
	Introduction	1
	Transmitting Technique	1
	Transmission of Letters	2
	Transmission of Numbers	3
	Transmission of Time	4
	Standard Words and Phrases	5
	Callsigns for Aeronautical Stations	7
	Callsigns for Aircraft	8
	Continuation of Communications	8
	Corrections and Repetitions	10
	Acknowledgement of Receipt	10
	Transfer of Communications	10

Clearance Issue and Read Back Requirements	11
Communication Failure	13
Test Transmissions	14
Pilot Complaints Concerning Aeronautical Telecommunications	15
Air Traffic Service Complaints Concerning Aircraft Communications	15
Hours of Service and Communications Watch	15
Record of Communications	16
Categories of Message	16

### **Chapter 3      General Phraseology**

General	1
Introduction	1
Level Instructions	1
Position Reporting	4
Flight Plans	4
Enroute Flight - Initial Call to an ATS Unit and reply to 'Pass Your Message'	6
Designated Positions in the Traffic Circuit	7

### **Chapter 4      Aerodrome Phraseology**

Aerodrome Control Service Phraseology	1
Introduction	1
Type of Service	1
Departure Information and Engine Starting Procedures	1
Pushback and Powerback	2
Taxi Instructions	2
Pre-Departure Manoeuvring	4
Take-Off Clearance	5
Aerodrome Traffic Circuit	8
Final Approach and Landing	10
Missed Approach	11
Runway Vacating and Communicating After Landing	12
Essential Aerodrome Information	12
Aerodrome Flight Information Service Phraseology	14
Introduction	14
Type of Service	14
AFIS Phraseology for Ground Movement, Take-off, Landing and Transit	15



Aerodrome Phraseology for Helicopters	18
Introduction	18
Helicopter Callsigns	18
Helicopter Phraseology for Taxiing	18
Helicopter Phraseology for Take-Off and Landing (ATC Only)	19
Helicopter Taxiing Phraseology Examples (ATC and AFIS Only)	20
Helicopter Take-Off and Landing Phraseology Examples (ATC only)	20
Aerodrome Phraseology for Vehicles (ATC and AFIS only)	22
Introduction	22
Movement Instructions	22
To Cross a Runway	23
Vehicles Towing Aircraft	24
Aerodrome Air/Ground Communication Service Phraseology	25
Introduction	25
Type of Service	25
Air/Ground Station Identification	25
Phraseology and Examples	25
Offshore Communication Service	28
Radiotelephony Reports at Unattended Aerodromes	32
Introduction	32
Additional Procedures for the Use of SAFETYCOM	32
Unattended Aerodrome Phraseology Examples	33
Aerodrome Information	35
Meteorological Conditions	35
Voice Weather Broadcast (VOLMET) UK	35
Runway Visual Range (RVR)/Visibility/Absolute Minimum	36
Runway Surface Conditions	36
Automatic Terminal Information Service (ATIS) UK	38

## **Chapter 5      Radar Phraseology**

General	1
Introduction	1
Radar Identification of Aircraft	1
Secondary Surveillance Radar Phraseology	2
Radar Service	4
Radar Vectoring	4
Traffic Information and Avoiding Action Phraseology	5

ACAS/TCAS Phraseology	6
Communications and Loss of Communications	7
Danger Area Crossing Service/Danger Area Activity Information Service	7

## **Chapter 6 Approach Phraseology**

Approach Control Service Phraseology	1
IFR Departures	1
VFR Departures	1
IFR Arrivals	2
VFR Arrivals	6
Special VFR Flights	7
Vectoring to Final Approach	7
Direction Finding (DF)	10
VDF Procedure	11
NDB(L) and VOR Procedures	15
Surveillance Radar Approach (SRA)	16
Landing Altimeter Setting (QNE)	18
PAR Approach	19
Military Aerodrome Traffic Zones (MATZ) and Penetration Services	24
Lower Airspace Radar Service (LARS)	24

## **Chapter 7 Area Phraseology**

Area Control Service Phraseology	1
General	1
Position Reporting	1
Flights Joining Airways	2
Flights Leaving Airways	2
Flights Crossing Airways	3
Flights Holding En-Route	3
Reduced Vertical Separation Minimum (RVSM) Phraseology	4

## **Chapter 8 Emergency Phraseology**

Distress and Urgency Communication Procedures	1
Introduction	1
States of Emergency	1
VHF Emergency Service	1

VHF Emergency Service – General Procedures	2
Emergency Message	3
Speechless Code	4
Radio Procedures – Practice Emergencies	4
Training Fix	5
Relayed Emergency Message	5
Imposition of Silence	5
Termination of Distress Communications and of RTF Silence	6

## **Chapter 9      Miscellaneous Phraseology**

Other Communications	1
Wake Vortex	1
Wind Shear	1
AIRPROX Reporting	1
Oil Pollution Reporting	2
Interceptions by Military Aircraft	2
Aircraft Operating Agency Messages	2
8.33 kHz Phraseology	3

## **Chapter 10     Phraseology Examples**

Examples of Types of Flights	1
Introduction	1
An IFR Flight	2
A VFR/IFR Flight	17
Flight in the Military Visual Circuit	25
Flight Receiving Lower Airspace Radar Service (LARS) and Danger Area Crossing Service (DACS)	29
Military Safety Broadcast - Sécurité	31
Callsign Prefix - TYRO	32
Flight Receiving Avoiding Action	33
Flight Receiving En-Route Flight Information Service	34
Flight Transmitting a Practice Pan	35
Arrival Flight (Aerodrome FIS)	37

## **Appendix 1     UK differences to ICAO Radiotelephony Procedures**

<b>Bibliography</b>	1
<b>Index</b>	1

# Revision History

## 1 Revisions included in Amendment 1 to Edition 15

1.1 In addition to editorial changes and minor corrections, Amendment 1 to Edition 15 comprises:

<b>General Phraseology</b>	Chapter 3 Paragraph 1.1.3	Requirement for the word 'degrees' to be appended to heading figures whenever a heading ends in zero, in order to avoid potential confusion with a flight level (thus avoiding a level bust).
	Chapter 3 Paragraph 1.1.4	Requirement for the word 'millibars' to be appended to pressure settings below 1000, in order to avoid potential confusion with a pressure setting utilising 'Inches of Mercury (Hg)' as used by some states.
<b>Aerodrome Phraseology</b>	Chapter 4 Paragraph 1.7.3	Requirement for the take-off clearance to be issued separately from any other clearance message.
	Chapter 4 Paragraph 1.7.10	Requirement for the separation of local departure instructions from the take-off clearance (including examples).
	Chapter 4 Paragraph 4.3.1	Changes to phraseology for vehicles to cross a runway, requiring that the holding point designator is included with the crossing instruction.
	Chapter 4 Paragraph 5.5.3	Changes to phraseology examples for 'the Offshore Aeronautical Service, when the deck is available' indicating that the words 'for landing' are optional, in order to reduce the wordiness of the message.  Addition of two paragraph notes: 1) To indicate that the meaning of 'Deck is available' is synonymous with the previous phraseology 'Deck is clear for landing'. 2) To refer pilots to the operator's Standard Operating Procedures, and AGCS operators to local procedures, for a description of company notification messages applicable in the offshore environment.
	Chapter 4 Paragraph 6.1.1	Specifying 135.475MHz as the common frequency notified for SAFETYCOM.
	Chapter 4 Paragraph 6.1.4	Requirement for transmissions at unattended aerodromes to be addressed to '[Aerodrome name] Traffic'

---

<b>Radar Phraseology</b>	Chapter 5 Paragraph 1.3.1 (Table) and Paragraph 1.3.2	Removal of SSR references to 'MODE ALPHA' as this phrase is no longer used in ICAO phraseology.
<b>Area Phraseology</b>	Chapter 7 Paragraph 1.7	Inclusion of phraseology applicable for Reduced Vertical Separation Minima (RVSM) operations.
<b>Miscellaneous Phraseology</b>	Chapter 9 Paragraph 1.1	Improved description of phraseology applicable for Wake Vortex spacing.
	Chapter 9 Paragraph 1.7.5 – Paragraph 1.7.7	Changes to phraseology to be used when using 8.33Khz channels
<b>Appendix 1</b>	Appendix 1 (Table of UK Differences to ICAO Radiotelephony Procedures)	Amendment to UK callsign requirements to allow aircraft category (e.g. helicopter or gyrocopter) to prefix the callsign.  Amendment to UK RVSM phraseology not requiring pilots to report non-RVSM status in all requests for level changes and in all readbacks of level changes.
<b>Index</b>		Updated to reflect repagination.

# Foreword

## 1 Document Description

### 1.1 Document Purpose

1.1.1 The aim of the United Kingdom Radiotelephony Manual (CAP 413) is to provide pilots and Air Traffic Services personnel with a compendium of clear, concise, standardised phraseology, and associated guidance, for radiotelephony communication in United Kingdom airspace.

### 1.2 Document Applicability

1.2.1 Radiotelephony (RTF) communications between United Kingdom air traffic services units and pilots are expected to comply with the phraseology described in this manual.

1.2.2 Operational details can be found in the United Kingdom Aeronautical Information Publication (UK AIP). Phraseology for air traffic controllers (consistent with CAP 413) is also published in the Manual of Air Traffic Services (CAP 493).

1.2.3 CAP 413 is also a useful reference for those studying for the UK Flight Radiotelephony Operator's Licence.

1.2.4 Candidates for JAA pilot and instrument rating examinations should note that the syllabus for the communications examination is drawn directly from the International Civil Aviation Organisation (ICAO) Annex 10 Volume 2 and ICAO Doc 9432-AN/925 and not CAP 413.

### 1.3 Document Source

1.3.1 The UK RTF Manual is based on ICAO Annex 10 Volume 2 (Communications Procedures) to the Convention on International Civil Aviation and ICAO PANS-ATM (Procedures for Air Navigation Services - Air Traffic Management) Doc. 4444.

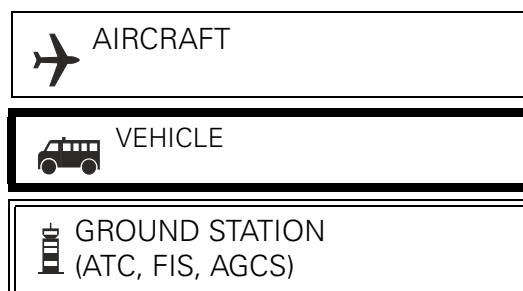
1.3.2 Where the ICAO standard phraseology may be misunderstood, or has weaknesses in the UK environment, different phraseology has been specified (and notified to ICAO). Significant differences between the ICAO standard phraseology and that specified for use in CAP 413 are described in Appendix 1 to this publication.

### 1.4 Document Format

1.4.1 Examples of phraseology in CAP 413 are intended to be representative of communications in common use. The initial call in a series of messages is shown on the left side of the page; subsequent messages appear in chronological order on the right side of the page.

1.4.2 Black text and grey-scale illustrations are used to facilitate printing on monochrome printers.

1.4.3 The agency making the transmission is identified by the line style of the frame and a representative symbol (e.g. Aircraft) as follows:



- 1.4.4 In this document the following protocol is used:
- The words '**must**' or '**shall**' indicate that compliance is compulsory.
  - The word '**should**' indicates a recommendation.
  - The word '**may**' indicates an option.
  - The word '**will**' is used to express the future.
- 1.4.5 Any reference in this document to the male gender should be understood to include both male and female persons.
- 1.5 **Document Revisions**
- 1.5.1 Major changes to RTF phraseology are notified by issuing an Aeronautical Information Circular (AIC). Revisions to CAP 413 are published at regular intervals.
- 1.5.2 Regular users of CAP 413 may wish to consider subscribing to the AIC Amendment Service in order to maintain the currency of this publication. Details of this service may be obtained from the Civil Aviation Authority at the address shown in the Bibliography at the end of this document.
- 1.5.3 When appropriate, loose-leaf amendments to this publication will be issued for insertion to the main document. When significant changes occur the document will be reissued as a new edition. The edition number and amendment status of the current version are shown inside the front cover.
- 1.5.4 When issuing amendments or a new edition, significant changes to the text are indicated by the use of sideline revision marks.
- 1.5.5 The revision date of an individual page can be determined from the date shown at the left footer. When a new edition is published, all pages will indicate the effective date of the complete edition.
- 1.5.6 Individual chapters in this publication are separately numbered to allow for the issue of amendment pages, without the need to renumber and reissue the entire document.
- 1.6 **Document Availability**
- 1.6.1 CAP 413 is available from the Civil Aviation Authority website at **[www.caa.co.uk/publications](http://www.caa.co.uk/publications)**. Visitors to the website may view, download and reproduce this file for use by their company or organisation, or for their own personal use.
- 1.6.2 Printed copies of CAP 413 are available for purchase from the CAA's sales agency for printed publications. Contact details are provided on the inside cover of this publication.
- 1.7 **Document Comments and Queries**
- 1.7.1 Should readers have any comments or queries regarding the contents of this document, they should contact the editor at the address provided on the inside cover of the publication.

# Chapter 1 Glossary

## 1 Terms

### 1.1 Definitions

**Absolute Minimum** The calculated RVR, or at aerodromes where; RVR measurements are not taken or available, the visibility, which is the lowest possible for any instrument approach to be made using that particular approach aid.

**Advisory Area** A designated area where air traffic advisory service is available.

**Advisory Route** A designated route along which air traffic advisory service is available.

**Aerodrome** Any area of land or water designed, equipped, set apart or commonly used for affording facilities for the landing and departure of aircraft.

**Aerodrome Control Service** Air traffic control service for aerodrome traffic.

**Aerodrome Flight Information Service (AFIS)** A flight information service provided to aerodrome traffic.

**Aerodrome Traffic** All traffic on the manoeuvring area of an aerodrome and all aircraft operating in the vicinity of an aerodrome.

**Aerodrome Traffic Zone** Airspace of defined dimensions established around an aerodrome for the protection of aerodrome traffic.

**Aeronautical Mobile Service** A radio communication service between aircraft stations and aeronautical stations, or between aircraft stations.

**Aeronautical Station** A land station in the aeronautical mobile service. In certain instances, an aeronautical station may be placed on board a ship or an earth satellite.

**Airborne Collision Avoidance System** An aircraft system based on SSR transponder signals which operates independently of groundbased equipment to provide advice to the pilot on potential conflicting aircraft that are equipped with SSR transponders.

**Aircraft Station** A mobile station in the aeronautical mobile service on board an aircraft.

**Air-ground Communications** Two-way communication between aircraft and stations or locations on the surface of the earth.

**Air/Ground Communication Service** A service that permits information to be passed from an aeronautical station to an aircraft station on or in the vicinity of an aerodrome.

**AIRPROX** A situation in which, in the opinion of a pilot or controller, the distance between aircraft as well as their relative positions and speed have been such that the safety of the aircraft involved was or may have been compromised.

**Air Traffic** All aircraft in flight or operating on the manoeuvring area of an aerodrome.

**Air Traffic Control Clearance** Authorisation for an aircraft to proceed under conditions specified by an air traffic control unit.



**Air Traffic Service (ATS)** A generic term meaning variously, flight information service, alerting service, air traffic advisory service, air traffic control service, area control service, approach control service or aerodrome control service.

**Airway** A control area or part of a control area established in the form of a corridor equipped with radio navigation aids.

**Altitude** The vertical distance of a level, a point or an object considered as a point, measured from mean sea level.

**Area Control Centre** A term used in the United Kingdom to describe a unit providing en-route air traffic control services.

**Automatic Terminal Information Service (ATIS) (UK)** The provision of current, routine information to arriving and departing aircraft by means of continuous and repetitive broadcasts throughout the day or a specified portion of the day.

**Base Turn** A turn executed by the aircraft during the initial approach between the end of the outboard track and the beginning of the intermediate or final approach track. The tracks are not reciprocal.

**Blind Transmission** A transmission from one station to another station in circumstances where two-way communication cannot be established but where it is believed that the called station is able to receive the transmission.

**Broadcast** A transmission of information relating to air navigation that is not addressed to a specific station or stations.

**Clearance Limit** The point to which an aircraft is granted an air traffic control clearance.

**Control Area** A controlled airspace extending upwards from a specified limit above the surface of the earth.

**Controlled Airspace** An airspace of defined dimensions within which air traffic control service is provided in accordance with the airspace classification.

**Control Zone** A controlled airspace extending upwards from the surface of the earth to a specified upper limit.

**Cruising Level** A level maintained during a significant portion of a flight.

**Decision Altitude/Height** A specified altitude/height in a precision approach at which a missed approach must be initiated if the required visual reference to continue the approach to land has not been established.

**Elevation** The vertical distance of a point or level on, or affixed to, the surface of the earth measured from mean sea level.

**Estimated Time of Arrival** The time at which the pilot estimates that the aircraft will be over a specific location.

**Flight Information Service (FIS)** A service provided for the purpose of giving advice and information useful for the safe and efficient conduct of flights.

**Flight Level** A surface of constant atmospheric pressure, which is related to a specific pressure datum, 1013.2 mb, and is separated from other such surfaces by specific pressure intervals.

**Flight Plan** Specified information provided to air traffic services units, relative to an intended flight or portion of a flight of an aircraft. Flight Plans fall into two categories: Full Flight Plans and Abbreviated Flight Plans.

**General Air Traffic** Flights operating in accordance with civil air traffic procedures.

**Heading** The direction in which the longitudinal axis of an aircraft is pointed, usually expressed in degrees from North (magnetic).

**Height** The vertical distance of a level, a point, or an object considered as a point measured from a specified datum.

**Holding Point** A speech abbreviation used in radiotelephony phraseology having the same meaning as Taxiway Holding Position as defined in CAP 168 Licensing of Aerodromes.

**IFR Flight** A flight conducted in accordance with the instrument flight rules.

**Instrument Meteorological Conditions (IMC)** Meteorological conditions expressed in terms of visibility, horizontal and vertical distance from cloud, less than the minima specified for visual meteorological conditions.

**Known Traffic** Traffic, the current flight details and intentions of which are known to the controller concerned through direct communication or co-ordination.

**Level** A generic term relating to the vertical position of an aircraft in flight and meaning variously, height, altitude or flight level.

**Level Bust** Any deviation from assigned altitude, height or flight level in excess of 300 feet.

**Microwave Approach** An approach executed by an aircraft, utilising a Microwave Landing System (MLS) for guidance.

**Minimum Descent Altitude/Height** A altitude/height in a nonprecision or circling approach below which descent may not be made without visual reference.

**Missed Approach Point (MAPt)** The point in an instrument approach procedure at or before which the prescribed missed approach procedure must be initiated in order to ensure that the minimum obstacle clearance is not infringed.

**Missed Approach Procedure** The procedure to be followed if the approach cannot be continued.

**Procedure Turn** A manoeuvre in which a turn is made away from a designated track followed by a turn in the opposite direction to permit the aircraft to intercept and proceed along the reciprocal of the designated track.

**Radar Approach** An approach, executed by an aircraft, under the direction of a radar controller.

**Radar Contact** The situation which exists when the radar blip or radar position symbol of a particular aircraft is seen and identified on a radar display.

**Radar Identification** The process of correlating a particular radar blip or radar position symbol with a specific aircraft.

**Radar Vectoring** Provision of navigational guidance to aircraft in the form of specific headings, based on the use of radar.

**Reporting Point** A specified geographical location in relation to which the position of an aircraft can be reported.

**Runway** A defined rectangular area on a land aerodrome prepared for the landing and take-off of aircraft.

**Runway Visual Range** The range over which the pilot of an aircraft on the centre line of a runway can expect to see the runway surface markings, or the lights delineating the runway or identifying its centre line.

**SAFETYCOM** A common frequency (135.475MHz) made available for use at aerodromes where no other frequency is allocated, to enable pilots to broadcast their intentions to other aircraft that may be operating on, or in the vicinity of, the aerodrome.

**Signal Area** An area on an aerodrome used for the display of ground signals.

**Significant Point** A specified geographical location used in defining an ATS route or the flight path of an aircraft and for other navigational and ATS purposes.

**Special VFR Flight** A flight made at any time in a control zone which is Class A airspace or is in any other control zone in IMC or at night, in respect of which the appropriate air traffic control unit has given permission for the flight to be made in accordance with special instructions given by that unit, instead of in accordance with the Instrument Flight Rules and in the course of which flight the aircraft complies with any instructions given by that unit and remains clear of cloud and in sight of the surface.

**Straight Ahead** When used in departure clearances means: 'track extended runway centre-line'.

When given in Missed Approach Procedures means: 'continue on Final Approach Track'.

**Terminal Control Area** A control area normally established at the confluence of airways in the vicinity of one or more major aerodromes.

**Threshold** The beginning of that portion of the runway useable for landing.

**Traffic Alert and Collision Avoidance System (TCAS)** See ACAS.

**VFR Flight** A flight conducted in accordance with the visual flight rules.

**Visual Meteorological Conditions (VMC)** Meteorological conditions expressed in terms of visibility, horizontal and vertical distance from cloud, equal to or better than specified minima.

## 1.2 Abbreviations

1.2.1 The following abbreviations are those in common use in the United Kingdom. If RTF transmission of an abbreviation is required, and the format is not specified in this document, the format specified by ICAO (see ICAO PANS-ABC Doc. 8400) should be used. If no format is defined, the abbreviation should be described using the phonetic alphabet.

1.2.2 The abbreviations annotated with an asterisk are normally spoken as complete words. The remainder are normally spoken using the constituent letters rather than the spelling alphabet.

### A

AAIB	Air Accident Investigation Branch
aal	Above Aerodrome Level
ACAS*	Airborne Collision Avoidance System (pronounced A-kas) (see TCAS)
ACC	Area Control Centre
ADF	Automatic Direction-Finding Equipment
ADR	Advisory Route
ADT	Approved Departure Time

---

AFTN	Aeronautical Fixed Telecommunication Network
AFIS	Aerodrome Flight Information Service
AGCS	Air Ground Communication Service
agl	Above Ground Level
AIC	Aeronautical Information Circular
AIP	Aeronautical Information Publication
AIRPROX*	Aircraft Proximity (replaces Airmiss/APHAZ)
AIS	Aeronautical Information Services
amsl	Above Mean Sea Level
ANO	Air Navigation Order
APAPI	Abbreviated Precision Approach Path Indicator (pronounced Ay-PAPI)
ATA	Actual Time of Arrival
ATC	Air Traffic Control (in general)
ATD	Actual Time of Departure
ATIS*	Automatic Terminal Information Service
ATS	Air Traffic Service
ATSU	Air Traffic Service Unit
AT-VASIS	Abbreviated T Visual Approach Slope Indicator System (pronounced Ay-Tee-VASIS)
ATZ	Aerodrome Traffic Zone
<b>C</b>	
CAA	Civil Aviation Authority
CAVOK*	Visibility, cloud and present weather better than prescribed values or conditions (CAVOK pronounced Cav-okay)
C/S	Callsign
CPDLC	Controller Pilot Data Link Communication (pronounced See Pee Dee Ell See) - A means of communication between a controller and aircrew using data link in conjunction with or instead of voice, for ATC.
CTA	Control Area
CTR	Control Zone
<b>D</b>	
DAAIS*	Danger Area Activity Information Service (DAAIS pronounced DAY-ES)
DACS*	Danger Area Crossing Service
DF	Direction Finding
DME	Distance Measuring Equipment
DR	Dead Reckoning

**E**

EAT	Expected Approach Time
ETA	Estimated Time of Arrival
ETD	Estimated Time of Departure
EGNOS*	European geostationary navigation overlay service

**F**

FAF	Final Approach Fix
FIR	Flight Information Region
FIS	Flight Information Service
FISO	Flight Information Service Officer
FL	Flight Level
Ft	Foot (feet)

**G**

GAT	General Air Traffic
GBAS*	Ground-based augmentation system (pronounced GEE-BAS)
GLONASS*	Global Orbiting Navigation Satellite System (pronounced Glo-NAS)
GMC	Ground Movement Control
GNSS	Global Navigation Satellite System
GPS	Global Positioning System
GRAS*	Ground-based regional augmentation system (pronounced GRASS)

**H**

H24	Continuous day and night service (H24 pronounced Aitch Twenty Fower)
HF	High Frequency
HJ	Sunrise to Sunset
HN	Sunset to Sunrise

**I**

IAF	Initial Approach Fix
ICAO*	International Civil Aviation Organisation
IF	Intermediate Approach Fix
IFR	Instrument Flight Rules
ILS	Instrument Landing System
IMC	Instrument Meteorological Conditions
IRVR	Instrumented Runway Visual Range

**K**

Kg Kilogramme(s)

kHz Kilohertz

Km Kilometre(s)

Kt Knot(s)

**M**

MAPt Missed Approach Point

MATZ\* Military Aerodrome Traffic Zone

mb Millibars

MDA/H Minimum Descent Altitude/Height

MEDA\* Military Emergency Diversion Aerodrome

MET\* Meteorological or Meteorology

METAR\* Routine aviation aerodrome weather report

MHz Megahertz

MLS Microwave Landing System

MOR Mandatory Occurrence Report

**N**

NATS National Air Traffic Services

NDB Non-Directional Radio Beacon

**O**

OAC Oceanic Area Control Unit

OCA Oceanic Control Area

OCA/H Obstacle Clearance Altitude/Height

OPC Operational Control Communications

**P**

PAPI\* Precision Approach Path Indicator (pronounced PAPI)

PAR Precision Approach Radar

**Q**

QDM Magnetic heading (zero wind) (Sometimes employed to indicate magnetic heading of a runway)

QDR Magnetic bearing

QFE Altimeter subscale setting to indicate height above either aerodrome elevation, or threshold elevation, or helideck elevation

QNE Landing altimeter reading when subscale set 1013 millibars

QNH Altimeter subscale setting to indicate elevation (AMSL) when on the ground and altitude in the air

QTE True Bearing

**R**

RA	Resolution Advisory (see TCAS)
RCC	Rescue Co-ordination Centre
RPS	Regional Pressure Setting
RTF	Radiotelephone/Radiotelephony
RVR	Runway Visual Range
RVSM	Reduced Vertical Separation Minima (pronounced Ahh Vee Ess Emm)

**S**

SAR	Search and Rescue
SBAS*	Satellite-based augmentation system (pronounced ESS-BAS)
SID*	Standard Instrument Departure
SIGMET*	Significant information concerning en-route weather phenomena which may affect the safety of aircraft operations
SRA	Surveillance Radar Approach
SSR	Secondary Surveillance Radar
STAR*	Standard Instrument Arrival

**T**

TA	Traffic Advisory (see TCAS)
TAF*	Terminal Aerodrome Forecast
TCAS*	Traffic Alert and Collision Avoidance System (pronounced Tee-kas) (see ACAS)
TMA	Terminal Control Area
T-VASIS	T Visual Approach Slope Indicator System (pronounced TEE-VASIS)

**U**

UAS	Upper Airspace
UHF	Ultra-High Frequency
UIR	Upper Flight Information Region
UTC	Co-ordinated Universal Time

**V**

VASIS*	Visual Approach Slope Indicator System (pronounced VASIS)
VDF	Very High Frequency Direction-Finding Station
VFR	Visual Flight Rules
VHF	Very High Frequency (30 to 300 MHz)
VMC	Visual Meteorological Conditions
VOLMET*	Meteorological information for aircraft in flight
VOR	VHF Omnidirectional Radio Range
VORTAC*	VOR and TACAN combination

## Chapter 2 Radiotelephony

### 1 General Procedures

#### 1.1 Introduction

Radiotelephony provides the means by which pilots and ground personnel communicate with each other. Used properly, the information and instructions transmitted are of vital importance in assisting in the safe and expeditious operation of aircraft. However, the use of non-standard procedures and phraseology can cause misunderstanding. Incidents and accidents have occurred in which a contributing factor has been the misunderstanding caused by the use of non-standard phraseology. **The importance of using correct and precise standard phraseology cannot be over-emphasised.**

#### 1.2 Transmitting Technique

1.2.1 The following transmitting techniques will assist in ensuring that transmitted speech is clearly and satisfactorily received.

- a) Before transmitting check that the receiver volume is set at the optimum level and listen out on the frequency to be used to ensure that there will be no interference with a transmission from another station.
- b) Be familiar with microphone operating techniques and do not turn your head away from it whilst talking or vary the distance between it and your mouth. Severe distortion of speech may arise from:
  - i) talking too close to the microphone
  - ii) touching the microphone with the lips
  - iii) holding the microphone or boom (of a combined headset/microphone system).
- c) Use a normal conversation tone, speak clearly and distinctly.
- d) Maintain an even rate of speech not exceeding 100 words per minute. When it is known that elements of the message will be written down by the recipients, speak at a slightly slower rate.
- e) Maintain the speaking volume at a constant level.
- f) A slight pause before and after numbers will assist in making them easier to understand.
- g) Avoid using hesitation sounds such as 'er'.
- h) Depress the transmit switch fully before speaking and do not release it until the message is complete. This will ensure that the entire message is transmitted. However, do not depress transmit switch until ready to speak.
- i) Be aware that the mother tongue of the person receiving the message may not be English. Therefore, speak clearly and use standard radiotelephony (RTF) words and phrases wherever possible.

1.2.2 One of the most irritating and potentially dangerous situations in radiotelephony is a 'stuck' microphone button. Operators should always ensure that the button is released after a transmission and the microphone placed in an appropriate place that will ensure that it will not inadvertently be switched on.



1.2.3 After a call has been made, a period of at least 10 seconds should elapse before a second call is made. This should eliminate unnecessary transmissions while the receiving station is getting ready to reply to the initial call.

### 1.3 Transmission of Letters

1.3.1 The words in the table below shall be used when individual letters are required to be transmitted. The syllables to be emphasised are underlined.

**Table 1**

Letter	Word	Appropriate pronunciation
A	Alpha	<u>AL</u> FAH
B	Bravo	<u>BRAH</u> VOH
C	Charlie	<u>CHAR</u> LEE
D	Delta	<u>DELL</u> TAH
E	Echo	<u>ECK</u> OH
F	Foxtrot	<u>FOKS</u> TROT
G	Golf	GOLF
H	Hotel	HOH <u>TELL</u>
I	India	<u>IN</u> DEE AH
J	Juliect	<u>JEW</u> LEE <u>ETT</u>
K	Kilo	<u>KEY</u> LOH
L	Lima	<u>LEE</u> MAH
M	Mike	MIKE
N	November	NO <u>VEM</u> BER
O	Oscar	<u>OSS</u> CAH
P	Papa	PAH <u>PAH</u>
Q	Quebec	KEH <u>BECK</u>
R	Romeo	<u>ROW</u> ME OH
S	Sierra	SEE <u>AIR</u> RAH
T	Tango	<u>TANG</u> GO
U	Uniform	<u>YOU</u> NEE FORM
V	Victor	<u>VIK</u> TAH
W	Whiskey	<u>WISS</u> KEY
X	X-ray	<u>ECKS</u> RAY
Y	Yankee	<u>YANG</u> KEE
Z	Zulu	<u>ZOO</u> LOO

## 1.4 Transmission of Numbers

1.4.1 The syllables to be emphasised are underlined.

**Table 2**

<b>Numeral or numeral element</b>	<b>Latin alphabet representation</b>
0	<u>Z</u> ERO
1	<u>W</u> UN
2	<u>T</u> OO
3	<u>T</u> REE
4	<u>F</u> OWER
5	<u>F</u> IFE
6	<u>S</u> IX
7	<u>S</u> EVEN
8	<u>A</u> IT
9	<u>N</u> INER
Decimal	<u>D</u> AY <u>S</u> EEMAL
Hundred	<u>H</u> UN <u>D</u> RED
Thousand	<u>T</u> OU <u>S</u> AND

1.4.2 All numbers, except those contained in paragraph 4.2(b) shall be transmitted by pronouncing each digit separately as follows:

- a) When transmitting messages containing aircraft callsigns, altimeter settings, flight levels (with the exception of FL 100, 200, 300 etc. which are expressed at 'Flight Level (number) HUN DRED'), headings, wind speeds/directions, pressure settings, transponder codes and frequencies, each digit shall be transmitted separately; examples of this convention are as follows:

**Table 3**

<b>Number</b>	<b>Transmitted as</b>	<b>Pronounced as</b>
BAW246	Speedbird Two Four Six	SPEEDBIRD TOO FOWER SIX
FL 100	Flight Level One Hundred	FLIGHT LEVEL WUN HUN DRED
FL 180	Flight Level One Eight Zero	FLIGHT LEVEL WUN AIT ZERO
150 Degrees	One Five Zero Degrees	WUN FIFE ZERO DEGREES
18 Knots	One Eight Knots	WUN AIT KNOTS
122.1	One Two Two Decimal One	WUN TOO TOO DAYSEEMAL WUN
6500	Six Five Zero Zero	SIX FIFE ZERO ZERO (SQUAWK)

- b) All numbers used in the transmission of altitude, height, cloud height, visibility and runway visual range information which contain whole hundreds and whole thousands shall be transmitted by pronouncing each digit in the number of hundreds or thousands followed by the word HUNDRED or TOUSAND as appropriate. Combinations of thousands and whole hundreds shall be transmitted by pronouncing each digit in the number of thousands followed by the word THOUSAND and the number of hundreds followed by the word HUNDRED; examples of this convention are as follows:

**Table 4**

Number	Transmitted as	Pronounced as
10	One Zero	WUN ZERO
100	One Hundred	WUN HUN DRED
2 500	Two Thousand Five Hundred	TOO TOUSAND FIFE HUNDRED
11 000	One One Thousand	WUN WUN TOUSAND
25 000	Two Five Thousand	TOO FIFE TOUSAND

- 1.4.3 Numbers containing a decimal point shall be transmitted as prescribed in 4.1 with the decimal point in appropriate sequence being indicated by the word decimal.

**Table 5**

Number	Transmitted as	Pronounced as
118.1	One One Eight Decimal One	WUN WUN AIT DAY SEE MAL WUN
120.375	One Two Zero Decimal Three Seven	WUN TOO ZERO DAY SEE MAL TREE SEVEN

**NOTE:** Only the first five figures are used when identifying frequencies separated by 25 kHz. See Chapter 9 for phraseology for operations in 8.33 kHz environments.

- 1.4.4 When it is necessary to verify the accurate reception of numbers the person transmitting the message shall request the person receiving the message to read back the numbers.

## 1.5 **Transmission of Time**

- 1.5.1 When transmitting time, only the minutes of the hour are normally required. However, the hour should be included if there is any possibility of confusion. Time checks shall be given to the nearest minute. Co-ordinated Universal Time (UTC) is to be used at all times, unless specified. 2400 hours designates midnight, the end of the day, and 0000 hours the beginning of the day.

**Table 6**

<b>Number</b>	<b>Transmitted as</b>	<b>Pronounced as</b>
0823	Two Three or Zero Eight Two Three	TOO TREE (or ZERO AIT TOO TREE)
1300	One Three Zero Zero	WUN TREE ZERO ZERO
2057	Five Seven or Two Zero Five Seven	FIFE SEVEN (or TOO ZERO FIFE SEVEN)

## 1.6 Standard Words and Phrases

The following words and phrases shall be used in radiotelephony communications as appropriate and shall have the meaning given below:

**Table 7**

<b>Word/Phrase</b>	<b>Meaning</b>
ACKNOWLEDGE	Let me know that you have received and understood this message.
AFFIRM	Yes.
APPROVED**	Permission for proposed action granted.
BREAK	Indicates the separation between messages.
BREAK BREAK	Indicates the separation between messages transmitted to different aircraft in a busy environment.
CANCEL	Annul the previously transmitted clearance.
CHANGING TO	I intend to call . . . (unit) on . . . (frequency).
CHECK	Examine a system or procedure. (Not to be used in any other context. No answer is normally expected.)
CLEARED †	Authorised to proceed under the conditions specified.
CLIMB †	Climb and maintain.
CONFIRM	I request verification of: ( <i>clearance, instruction, action, information</i> ).
CONTACT	Establish communications with ... (your details have been passed).
CORRECT	True or accurate.
CORRECTION	An error has been made in this transmission (or message indicated). The correct version is ...
DESCEND †	Descend and maintain.
DISREGARD	Ignore.
FANSTOP	I am initiating a practice engine failure after take off. (Used only by pilots of single engine aircraft.) The response should be, "REPORT CLIMBING AWAY"
FREECALL	Call . . . (unit) (your details have not been passed – mainly used by military ATC).

**Table 7**

<b>Word/Phrase</b>	<b>Meaning</b>
HOLD SHORT**	Stop before reaching the specified location . <i>Note: Only used in limited circumstances where no defined point exists (e.g. where there is no suitably located holding point), or to reinforce a clearance limit.</i>
HOW DO YOU READ	What is the readability of my transmission?
I SAY AGAIN	I repeat for clarity or emphasis.
MAINTAIN ‡	Continue in accordance with the condition(s) specified or in its literal sense, e.g. "Maintain VFR"
MONITOR	Listen out on (frequency).
NEGATIVE	No; or Permission not granted; or That is not correct; or Not capable.
OUT*	This exchange of transmissions is ended and no response is expected.
OVER*	My transmission is ended and I expect a response from you.
PASS YOUR MESSAGE	Proceed with your message.
READ BACK	Repeat all, or the specified part, of this message back to me exactly as received.
REPORT **	Pass requested information.
REQUEST	I should like to know ... or I wish to obtain ...
ROGER	I have received all your last transmission. <i>Note: Under no circumstances to be used in reply to a question requiring a direct answer in the affirmative (AFFIRM) or negative (NEGATIVE).</i>
SAY AGAIN	Repeat all, or the following part of your last transmission.
SPEAK SLOWER	Reduce your rate of speech.
STANDBY	Wait and I will call you. <i>Note: No onward clearance to be assumed. The caller would normally re-establish contact if the delay is lengthy. STANDBY is not an approval or denial.</i>
UNABLE	I cannot comply with your request, instruction or clearance. <i>Unable is normally followed by a reason.</i>
WILCO	I understand your message and will comply with it (abbreviation for will comply)
WORDS TWICE	<i>As a request:</i> Communication is difficult. Please send every word twice. <i>As Information:</i> Since communication is difficult, every word in this message will be sent twice.

\* Not normally used in U/VHF Communications.

\*\* Not used by Air/Ground Communication Service Operators (c/s "Radio").

‡ Not used by Air/Ground Communication Service Operators (c/s "Radio") or Flight Information Service Officers (c/s "Information").

## 1.7 Callsigns for Aeronautical Stations

1.7.1 Aeronautical stations are identified by the name of the location followed by a suffix except that the name of the rig/platform/vessel is normally used by offshore mineral extraction agencies. The suffix indicates the type of service being provided.

**Table 8**

Service	Suffix
Area Control	CONTROL
Radar (in general)	RADAR
Approach Control	APPROACH
Aerodrome Control	TOWER
Approach Control Radar Arrival/Departure	DIRECTOR/DEPARTURE (RADAR – when tasks combined)/ ARRIVAL – (when approved))
Ground Movement Control	GROUND
Precision Approach Radar	TALKDOWN (Military – FINAL CONTROLLER)
Flight Information	INFORMATION
Air/Ground Communication Service	RADIO
Ground Movement Planning	DELIVERY

1.7.2 There are three main categories of aeronautical communications service:

- Air Traffic Control Service (ATC) which can only be provided by licensed Air Traffic Control Officers who are closely regulated by the CAA.
- Flight Information Service at aerodromes can be provided only by licensed Flight Information Service Officers (FISOs), who are also regulated by the CAA.
- Aerodrome Air/Ground Communication Service (AGCS) which can be provided by Radio Operators who are not licensed but have obtained a certificate of competency to operate radio equipment on aviation frequencies from the CAA. These operations come under the jurisdiction of the radio license holder, but are not regulated in any other way.

1.7.3 It is an offence to use a callsign for a purpose other than that for which it has been notified.

1.7.4 When satisfactory communication has been established, and provided that it will **not be confusing**, the name of the location or the callsign suffix may be omitted.

1.7.5 It is correct procedure to announce identity on all telephone calls: with incoming calls it is the opening remark and with outgoing calls it is the reply to the recipient's announcement of identity. FISOs and AGCS operators must never identify themselves as '....air traffic control'. It is just as important that this procedure is not relaxed for direct telephone lines because mistaken identity can occur when another line has been inadvertently left open from a previous call. The identity to be used is that of the function relative to the telephone extension being used.

## 1.8 Callsigns for Aircraft

- 1.8.1 When establishing communication, an aircraft shall use the full callsigns of both stations.



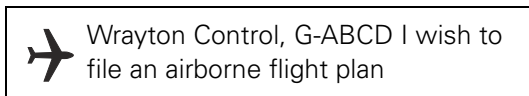
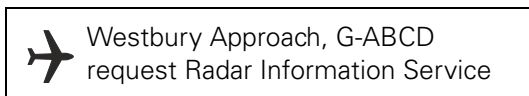
- 1.8.2 After satisfactory communication has been established and provided that no confusion is likely to occur, the ground station may abbreviate callsigns (see table below). A pilot may **only** abbreviate the callsign of his aircraft if it has **first** been abbreviated by the aeronautical station.

**Table 9**

Full callsign	Abbreviation
GBFRM	G-RM
Speedbird GBGDC	Speedbird DC
N31029	N029
N753DA	N3DA
Midland 640	No abbreviation
* Piper GBSZT	Piper ZT

\* The name of either the aircraft manufacturer, or name of aircraft model, or name of the aircraft category (e.g. helicopter or gyrocopter) may be used as a prefix to the callsign.

- 1.8.3 An aircraft should request the service required on initial contact when freecalling a ground station.



- 1.8.4 An aircraft shall not change its callsign type during a flight. **However**, where there is a likelihood that confusion may occur because of similar callsigns, an aircraft may be instructed by an air traffic service unit (ATSU) to change the type of its callsign temporarily.

- 1.8.5 Aircraft in the heavy wake vortex category shall include the word 'HEAVY' immediately after the aircraft callsign in the initial call to each ATSU.

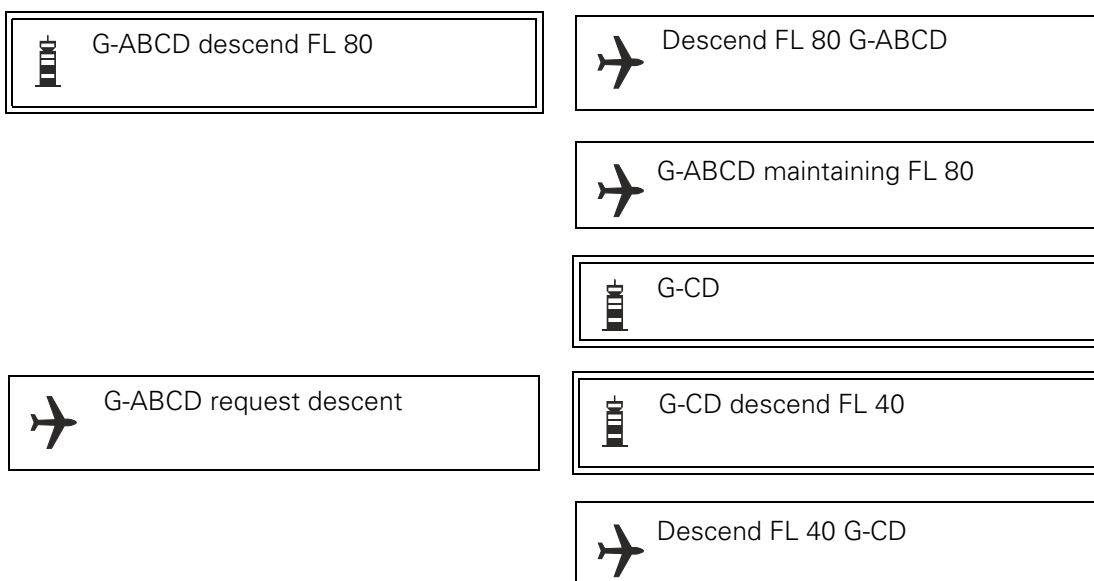
## 1.9 Continuation of Communications

- 1.9.1 The placement of the callsigns of both the aircraft and the ground station **within** an established RTF exchange should be as follows:

Ground to Air: Aircraft callsign – message or reply.

Air to Ground:

- a) Initiation of new information/request etc. – Aircraft callsign then message;
- b) Reply – Repeat of pertinent information/readback/acknowledgement then aircraft callsign.



1.9.2 When it is considered that reception is likely to be difficult, important elements of the message should be spoken twice.

1.9.3 When a ground station wishes to broadcast information to all aircraft likely to receive it, the message should be prefaced by the call 'All stations'.

No reply is expected to such general calls unless individual stations are subsequently called upon to acknowledge receipt.

 All stations Wrayton control, Colinton VOR on test
---


1.9.4 If there is doubt that a message has been correctly received, a repetition of the message shall be requested either in full or in part.


**Table 10**

Phrase	Meaning
Say again	Repeat entire message
Say again ... (item)	Repeat specific item
Say again all before ... (the first word satisfactorily received)	
Say again all after ... (the last word satisfactorily received)	
Say again ... (word before missing portion) to ... (word after missing portion)	




- 1.9.5 When a station is called but is uncertain of the identification of the calling station, the calling station should be requested to repeat its callsign until identification is established.


 Stourton Ground Fastair 345

 Station calling Stourton Ground say again your callsign

### 1.10 Corrections and Repetitions

- 1.10.1 When an error is made in a transmission the word 'CORRECTION' shall be spoken, the last correct group or phrase repeated and then the correct version transmitted.

 Fastair 345 Wicken 47  
FL 280 Marlow 07  
correction Marlow 57

 Fastair 345 Roger


- 1.10.2 If a correction can best be made by repeating the entire message, the operator shall use the phrase 'CORRECTION I SAY AGAIN' before transmitting the message a second time.


### 1.11 Acknowledgement of Receipt

Acknowledgements of information should be signified by the use of the receiving stations' callsign or Roger callsign, and not by messages such as: 'callsign-copy the weather' or 'callsign-copy the traffic'.

### 1.12 Transfer of Communications

- 1.12.1 An aircraft will normally be advised by the appropriate aeronautical station to change from one radio frequency to another in accordance with agreed procedures.


 Fastair 345 contact Wrayton Control 129.1


 Wrayton Control 129.1  
Fastair 345


**In the absence of such advice, the aircraft shall notify the aeronautical station before such a change takes place.** Aircraft flying in controlled airspace must obtain permission from the controlling authority before changing frequency.

- 1.12.2 An aircraft may be instructed to 'standby' on a frequency when it is intended that the ATSU will initiate communications, and to monitor a frequency on which information is being broadcast.


 Fastair 345 standby 118.9 for Kennington Tower


 Standby 118.9 for Kennington Tower  
Fastair 345

 Fastair 345 monitor 128.2 for ATIS

 Monitor 128.2 for ATIS  
Fastair 345


- 1.12.3 If the airspace does not dictate that an aircraft must remain in contact with a specific ATSU and the pilot wishes to freecall another agency he should request, or notify such an intention.


 Westbury G-ABCD request change to Wrayton Information on 125.75


 Wrayton Information G-ABCD changing to Wrayton Centre on 121.5 for Practice Pan


### 1.13 Clearance Issue and Read Back Requirements

- 1.13.1 Provisions governing clearances are contained in the PANS-ATM (ICAO Doc 4444). A clearance may vary in content from a detailed description of the route and levels to be flown to a brief standard instrument departure (SID) according to local procedures.
- 1.13.2 Controllers will pass a clearance slowly and clearly since the pilot needs to write it down; wasteful repetition will thus be avoided. Whenever possible, a route clearance should be passed to an aircraft before start up and the aircraft's full callsign will always be used. **Generally, controllers will avoid passing a clearance to a pilot engaged in complicated taxiing manoeuvres and on no occasion when the pilot is engaged in line up or take-off manoeuvres.**
- 1.13.3 An ATC route clearance is **NOT** an instruction to take-off or enter an active runway. **The words 'TAKE-OFF' are used only when an aircraft is cleared for take-off. At all other times the word 'DEPARTURE' is used.**
- 1.13.4 The stringency of the read back requirement is directly related to the possible seriousness of a misunderstanding in the transmission and receipt of ATC clearance and instructions. **ATC route clearances shall always be read back unless otherwise authorised by the appropriate ATS authority** in which case they shall be acknowledged in a positive manner. Read backs shall always include the aircraft callsign.


 Fastair 345 cleared to Kennington via A1, at FL 60, request level change en-route, squawk 5501


 Cleared to Kennington via A1, at FL 60, request level change en-route, squawk 5501 Fastair 345


 Fastair 345 correct


 Fastair 345 cleared to Kennington via A1, Wicken 3 Delta departure, squawk 5501

 Cleared to Kennington via A1, Wicken 3 Delta departure, squawk 5501, Fastair 345

 Fastair 345 correct

 G-ABCD after departure cleared to zone boundary via route Echo. Climb to altitude 2000 feet QNH 1008, squawk 6522

 After departure cleared to zone boundary via route Echo. Climb to altitude 2000 feet QNH 1008, squawk 6522 G-ABCD

 G-CD correct

1.13.5 Pilots of departing aircraft flying in controlled airspace which suffer radio communication failure prior to reaching cruising level should be aware of the procedures to be adopted when the following types of clearance (detailed in UK AIP ENR) are issued:

- a) Request level change en-route.
- b) Climb under radar.
- c) Temporary restriction to climb.

1.13.6 The ATS messages listed below are to be read back in full by the pilot/driver. If a readback is not received the pilot/driver will be asked to do so. Similarly, the pilot/driver is expected to request that instructions are repeated or clarified if any are not fully understood.

Taxi/Towing Instructions

Level Instructions

Heading Instructions

Speed Instructions

Airways or Route Clearances

Approach Clearances

Runway-in-Use

Clearance to Enter, Land On, Take-Off On, Backtrack, Cross, or Hold Short of any Active Runway

SSR Operating Instructions









Altimeter Settings

VDF Information


Frequency Changes


Type of Radar Service

Transition Levels


 G-ABCD cleared to cross A1 at Wicken, maintain FL 70 whilst in controlled airspace. Report entering the airway	 Cleared to cross A1 at Wicken, maintain FL 70 in controlled airspace, Wilco. G-ABCD
 G-CD hold position	 Holding G-CD
 G-CD contact Ground 118.05	 Ground on 118.05 G-CD
 Fastair 345 Squawk 6402	 6402 Fastair 345

- 1.13.7 Items which do not appear in the above list may be acknowledged with an abbreviated read back.


 Fastair 345 after the B747 passing left to right, taxi holding point A2 runway 23


 After the B747, holding point A2 runway 23, Fastair 345

- 1.13.8 If an aircraft read back of a clearance or instruction is incorrect, the controller shall transmit the word 'NEGATIVE' followed by the correct version.


 G-CD QNH 1003


 QNH 1013 G-CD

 G-CD Negative, QNH 1003

 QNH 1003, G-CD

- 1.13.9 If at any time a pilot receives a clearance or instruction with which he cannot comply, he should advise the controller using the phrase 'UNABLE' (COMPLY) and give the reason(s).

 Fastair 345 Wrayton climb FL 280, cross Wicken FL 150 or above

 Wrayton Fastair 345 unable cross Wicken FL 150 due weight

## 1.14 **Communication Failure**

### 1.14.1 **Air – Ground**

- a) Check the following points:
  - i) The correct frequency has been selected for the route being flown.
  - ii) The Aeronautical Station being called is open for watch.
  - iii) The aircraft is not out of radio range.
  - iv) Receiver volume correctly set.
- b) If the previous points are in order it may be that the aircraft equipment is not functioning correctly. Complete the checks of headset and radio installation appropriate to the aircraft.
- c) When an aircraft station is unable to establish contact with the aeronautical station on the designated frequency it shall attempt to establish contact on another frequency appropriate to the route being flown. If this attempt fails, the aircraft station shall attempt to establish communication with other aircraft or other aeronautical stations on frequencies appropriate to the route.
- d) The pilot may still be unable to establish communication on any designated aeronautical station frequency, or with any other aircraft. The pilot is then to transmit his message twice on the designated frequency, including the addressee for whom the message is intended, preceded by the phrase 'TRANSMITTING BLIND' in case the transmitter is still functioning.

- e) Where a transmitter failure is suspected, check or change the microphone. Listen out on the designated frequency for instructions. It should be possible to answer questions by use of the carrier wave if the microphone is not functioning (see Chapter 8 paragraph 1.6).
- f) In the case of a receiver failure transmit reports twice at the scheduled times or positions on the designated frequency preceded by the phrase 'TRANSMITTING BLIND DUE TO RECEIVER FAILURE'.
- g) An aircraft which is being provided with air traffic control service, advisory service or aerodrome flight information service is to transmit information regarding the intention of the pilot in command with respect to the continuation of the flight. Specific procedures for the action to be taken by pilots of IFR and Special VFR flights are contained in the appropriate AIP ENR and/or AD sections.

#### 1.14.2 **Ground – Air**

- 1.14.2.1 After completing checks of ground equipment (most airports have standby and emergency communications equipment) the ground station will request other aeronautical stations and aircraft to attempt to communicate with the aircraft which has failed to maintain contact.
- 1.14.2.2 If still unable to establish communication the aeronautical station will transmit messages addressed to the aircraft by blind transmission on the frequency on which the aircraft is believed to be listening.
- 1.14.2.3 These will consist of:
  - a) The level, route and EAT (or ETA) to which it is assumed the aircraft is adhering.
  - b) The weather conditions at the destination aerodrome and suitable alternate and, if practicable, the weather conditions in an area or areas suitable for descent through cloud procedure to be effected. (See AIP ENR Section.)

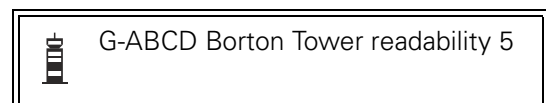
#### 1.15 **Test Transmissions**

- 1.15.1 All radio transmissions for test purposes shall be of the minimum duration necessary for the test and shall not continue for more than 10 seconds. The recurrence of such transmissions shall be kept to the minimum necessary for the test.
- 1.15.2 The nature of the test shall be such that it is identifiable as a test transmission and cannot be confused with other communications. To achieve this the following format shall be used:
  - the callsign of the aeronautical station being called;
  - 'the aircraft identification';
  - the words 'RADIO CHECK';
  - 'the frequency (or 8.33 channel)' being used;
- 1.15.3 The operator of the aeronautical radio station being called will assess the transmission and will advise the aircraft making the test transmission in terms of the readability scale (Table 11), together with a comment on the nature of any abnormality noted (i.e. excessive noise) using the following format:
  - 'the aircraft identification';
  - 'the callsign' of the aeronautical station replying;
  - 'READABILITY x' (where 'x' is a number taken from Table 11);
  - 'additional information' with respect to any noted abnormality;

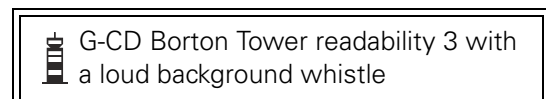
**NOTE:** For practical reasons it may be necessary for the operator of an aeronautical station to reply with 'STATION CALLING (*frequency or 8.33 channel*) UNREADABLE'.

**Table 11**

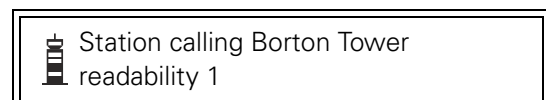
Readability Scale	Meaning
1	Unreadable
2	Readable now and then
3	Readable but with difficulty
4	Readable
5	Perfectly readable



or,



or,



### 1.16 Pilot Complaints Concerning Aeronautical Telecommunications

Pilots should report faults concerning services and facilities in the Aeronautical Mobile Broadcast and Navigation Services to the Briefing Officer, Senior Telecommunications Officer or Senior Controller at the destination or airport of first landing in order that remedial action can be taken. Reports of local unserviceabilities will be forwarded to the Telecommunications staff if received on RTF by the ATSU.

### 1.17 Air Traffic Service Complaints Concerning Aircraft Communications

Aircraft radio faults including technical failure, incorrect operating procedures and misuse of specific radio channels may result in the aircraft operator receiving a communication from the CAA detailing the fault condition inviting the operator to explain and/or state what corrective action has been taken.

### 1.18 Hours of Service and Communications Watch

1.18.1 The hours of service of the radio facilities available in the United Kingdom are published in the UK AIP (ENR and AD) which also details those periods set aside for maintenance.

1.18.2 Aircraft stations shall, if possible, communicate directly with the ATSU appropriate to the area in which the aircraft are flying. If unable to do so, aircraft stations shall use any relay means available and appropriate to transmit messages to the ATSU.

1.18.3 When normal communications from an aeronautical station to an aircraft station cannot be established, the aeronautical station shall use any relay means available and appropriate to transmit messages to the aircraft station.

1.18.4 When an aircraft has established communication with an ATSU it is required to maintain a listening watch with that ATSU and advise the ATSU when the listening watch is about to cease. Aircraft should not cease to maintain a listening watch, except for reasons of safety, without informing the ATSU concerned. A time at which it is expected that the watch will be resumed must be stated.

### 1.19 **Record of Communications**

All ATC units have automatic equipment to record air-ground communications and some other ATS units (e.g. AFIS) also have such equipment.

### 1.20 **Categories of Message**

The categories of messages handled by the aeronautical mobile service are in the following order of priority:

- a) Distress messages
  - b) Urgency messages
  - c) Communications relating to direction finding
  - d) Flight safety messages
  - e) Meteorological messages
  - f) Flight Regularity messages
- } See Chapter 8 – Emergency Phraseology
- See Chapter 6 paragraph 1.7
- See Chapter 9 paragraph 1.6
- See Chapter 4 section 5
- See Chapter 9 paragraph 1.6.

## Chapter 3 General Phraseology

### 1 General

#### 1.1 Introduction













- 1.1.1 The phraseology detailed in this manual has been established for the purpose of ensuring uniformity in RTF communications. Communications shall be concise and unambiguous, using standard phraseology for all situations for which it is specified. Obviously, it is not practicable to detail phraseology examples suitable for every situation. However, if standard phrases are adhered to when composing a message, any possible ambiguity will be reduced to a minimum. Only when standard phraseology cannot serve an intended transmission, shall plain language be used.
- 1.1.2 Some abbreviations, which by their common usage have become part of aviation terminology, may be spoken using their constituent letters rather than the spelling alphabet, for example, ILS, QNH, RVR, etc., (see Chapter 1, paragraph 1.2).
- 1.1.3 For all transmissions, with the exception of those used for surveillance radar approaches or precision radar approaches, the word 'degrees' shall be appended to heading figures where the heading ends in zero, or in cases where confusion or ambiguity may result.
- 1.1.4 For all transmissions, the word 'millibar' shall be appended to figures when transmitting a pressure setting below 1000 mb, or in cases where confusion or ambiguity may result.
- 1.1.5 The following words may be omitted from transmissions provided that no confusion or ambiguity may result:
- 'Surface' and 'knots' in relation to surface wind direction and speed.
  - 'Degrees' in relation to surface wind direction.
  - 'Visibility', 'cloud' and 'height' in meteorological reports.
  - 'over', 'roger' and 'out'.
- 1.1.6 The excessive use of courtesies should be avoided.

#### 1.2 Level Instructions

- 1.2.1 Only basic level instructions are detailed in this chapter. More comprehensive phrases are contained in subsequent chapters in the context in which they are most commonly used.
- 1.2.2 The precise phraseology used in the transmission and acknowledgement of climb and descent clearances will vary, depending upon the circumstances, traffic density and nature of the flight operations.
- 1.2.3 However, care must be taken to ensure that misunderstandings are not generated as a consequence of the phraseology employed during these phases of flight. For example, levels may be reported as altitude, height or flight levels according to the phase of flight and the altimeter setting. Therefore, when passing level messages, the following conventions apply:
- The word 'to' is to be omitted from messages relating to FLIGHT LEVELS.
  - All messages relating to an aircraft's climb or descent to a HEIGHT or ALTITUDE employ the word 'to' followed immediately by the word HEIGHT or ALTITUDE. Furthermore, the initial message in any such RTF exchange will also include the appropriate QFE or QNH.
















- c) The phrase 're-cleared' should not be employed.
- d) When transmitting messages containing flight levels each digit shall be transmitted separately. However, in an endeavour to reduce 'level busts' caused by the confusion between some levels (100/110, 200/220 etc.), levels which are whole hundreds e.g. FL 100, 200, 300 shall be spoken as "Flight level (number) HUN DRED". The word hundred must not be used for headings.

 G-CD report your level	 G-CD maintaining FL 65
	 G-CD descend FL 45
	 Descend FL 45 G-CD
 G-CD report your level	 G-CD maintaining altitude 2500 feet Wessex 998 millibars
	 G-CD descend to altitude 2000 feet Borton QNH 1000
	 Descend to altitude 2000 feet Borton QNH 1000 G-CD
	 G-CD descend to altitude 1500 feet
	 Descend to altitude 1500 feet G-CD
	 G-CD descend to height 1000 feet QFE 997 millibars
	 Descend to height 1000 feet QFE 997 millibars G-CD






- NOTES:**
- 1 Use of the word 'millibars' for pressures lower than 1000
  - 2 Transmission of Regional Pressure Setting (Wessex) limited to regional name and pressure.

1.2.3.1 In the following examples the operations of climbing and descending are interchangeable and examples of only one form are given.

 G-CD report passing FL 80	 Report passing FL 80 G-CD
---	---

	 G-CD passing FL 80
 G-CD maintain altitude 2500 feet	 Maintaining altitude 2500 feet G-CD
 G-CD climb FL 70	 Climb FL 70 G-CD
	 G-CD reaching FL 70
 G-CD request descent	 G-CD descend FL 60
	 Descend FL 60 G-CD
 Fastair 345 after passing North Cross descend FL 80	 After passing North Cross descend FL 80 Fastair 345
 Fastair 345 stop descent FL 210	 Stop descent FL 210 Fastair 345

1.2.3.2 Exceptionally, a best rate of climb or descent may be required.


 Fastair 345 expedite descent FL 180	 Expedite descent FL 180 Fastair 345
 Fastair 345 climb FL 280 expedite until passing FL 180	 Climb FL 280 expedite until passing FL 180 Fastair 345
or,	
	 Fastair 345 unable expedite climb due weight


1.2.3.3 Under exceptional circumstances, if instant descent/climb is required, the word 'immediately' shall be used.


 Fastair 345 descend immediately FL 200 due traffic	 Descend immediately FL 200 Fastair 345
--	--


1.2.3.4 **Pilots are expected to comply with ATC instructions as soon as they are issued.** However, when a climb/descent is left to the discretion of the pilot, the words 'when ready' shall be used; in these circumstances the pilot will report 'leaving' his present level. **Should pilots be instructed to report leaving a level, they should inform**

**ATC that they have left an assigned level only when the aircraft's altimeter indicates that the aircraft has actually departed from that level and is maintaining a positive rate of climb or descent, in accordance with published procedures.**

 Fastair 345 when ready climb FL 280

 When ready climb FL 280 Fastair 345


 Fastair 345 leaving FL 200 climbing FL 280

 Fastair 345

### 1.3 Position Reporting


1.3.1 Position reports shall contain the following elements of information:

- a) Aircraft identification
- b) Position
- c) Time
- d) Level
- e) Next position and ETA


 Fastair 345 Wicken 47 FL 280 Marlow 57


 Fastair 345


1.3.2 Where adequate flight progress data is available from other sources, such as ground radar, aircraft may be exempted from the requirement to make compulsory position reports.


 Fastair 345 next report at Colinton

 Wilco Fastair 345

 Fastair 345 omit position reports this frequency


 Wilco Fastair 345

 Fastair 345 resume position reporting

 Wilco Fastair 345

### 1.4 Flight Plans

1.4.1 A pilot may file a flight plan with an ATSU during flight, although the use of busy RTF channels should be avoided; normally the FIS frequency should be used.

 Wrayton Control G-ABCD I wish to file an airborne flight plan


 G-ABCD Wrayton Control pass your message

1.4.2 The format for an airborne flight plan is as follows:


- a) Aircraft identification and type.
- b) Position and heading.
- c) Level and flight conditions.
- d) Departure aerodrome.
- e) Estimated time at entry point.
- f) Route and point of first intended landing.
- g) True airspeed.
- h) Desired level on airway or advisory route.


1.4.3 During a flight a pilot may elect to cancel an IFR flight plan.

 Wrayton control G-CD cancel my IFR flight plan

 G-CD Roger IFR flight plan cancelled at time 47

1.4.4 When a pilot has expressed his intention to cancel an IFR flight plan, the ATSU will pass the pilot any available meteorological information which makes it likely that flight in VMC cannot be maintained.

 G-CD IMC reported in the vicinity of Kennington

 G-CD Roger remaining IFR

## 1.5 Enroute Flight - Initial Call to an ATS Unit and reply to 'Pass Your Message'

1.5.1 Generally, the format of this call is applicable to aircraft operating under Visual Flight Rules (VFR), however the format specified could be used by aircraft operating under Instrument Flight Rules (IFR) when contacting an ATS unit that does not hold details of the flight.

1.5.2 The service that an enroute flight requires should be identified in the initial call to an ATS unit.

	Westbury Approach, G-ABCD Request Flight Information Service
---	---

1.5.3 When instructed by the ATS Unit to 'Pass Your Message' the reply should contain the following information, whenever possible in the order specified:

**a) Aircraft Callsign / Type**


**b) Departure Point and Destination**


**c) Present Position**


**d) Level**


**e) Additional details / Intention** (e.g. Flight Rules, Next route point)

Reply Example 1:


	G-CD Westbury Pass Your Message
---	------------------------------------


	G-CD, Cessna 172, from Bolton to Walden, 15nm South of Westbury, altitude 2500 feet Wessex 1008, VFR tracking to Wells
---	--


	G-CD, Roger, No reported traffic, Report Wells
---	--


	G-CD, Wilco
---	-------------

Reply Example 2: An aircraft returning to the aerodrome of departure.

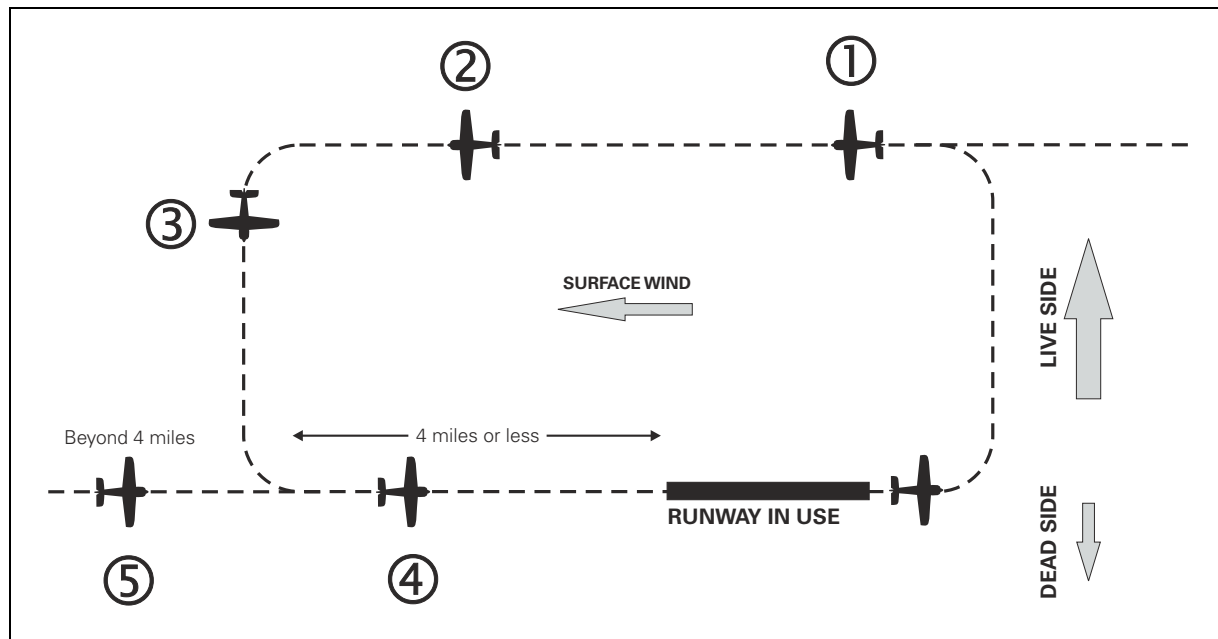
	G-CD Westbury, Pass Your Message
---	-------------------------------------

	G-CD, PA28, Local flight from Borton, Wells, altitude 3500ft Wessex 1008, VFR tracking to Salisbury
---	--

	G-CD, Roger, Traffic is a Cessna 172, 15nm South of Westbury, VFR tracking to Wells at 2500ft, Report Salisbury
---	--

	G-CD, Wilco
---	-------------

## 1.6 Designated Positions in the Traffic Circuit



**Figure 1** Designated positions in the traffic circuit

### Typical Left-Hand Circuit

- Position 1** Aircraft reports on '**Downwind**' leg.
- Position 2** Aircraft reports '**Late downwind**' if it is on the downwind leg, has been unable to report '**Downwind**' and has passed the downwind end of the runway.
- Position 3** Aircraft reports '**Base**' leg (if required).
- Position 4** Aircraft reports '**Final**'. Clearance to land issued here.
- Position 5** Aircraft reports '**Long final**' (between 8 and 4 miles) when aircraft is on a straight in approach.

**NOTE 1:** For light aircraft operations, circuit dimensions may be reduced but the relative RTF reporting points are maintained.

**NOTE 2:** For details of the standard overhead joining procedure see Aerodrome Traffic Circuit (Chapter 4 Paragraph 1.8) and RTF Reports at Unattended Aerodromes (Chapter 4 Paragraph 6.8)

## Chapter 4 Aerodrome Phraseology

### 1 Aerodrome Control Service Phraseology

#### 1.1 Introduction


- 1.1.1 Concise and unambiguous phraseology used at the correct time is vital to the smooth, safe and expeditious running of an aerodrome and associated ATZ. It is not only the means by which instructions and information are passed but it also assists pilots in maintaining an awareness of other traffic in their vicinity, particularly in poor visibility conditions.
- 1.1.2 Messages will not be transmitted to an aircraft during take-off, the last part of final approach or the landing roll, unless it is necessary for safety reasons, because it will be distracting to the pilot at a time when the cockpit workload is often at its highest.
- 1.1.3 Local procedures vary from aerodrome to aerodrome and it is impossible to give examples to cover every situation which may arise at the multiplicity of different types of aerodrome. Information in addition to that shown in the examples, e.g. time checks, etc. may be provided as necessary.


#### 1.2 Type of Service


- 1.2.1 As described in Chapter 2 the type of service provided at an aerodrome falls into one of three categories. In this section the examples are confined to those used by air traffic controllers.
- 1.2.2 Whilst the RTF procedures used by air traffic controllers form the main content of this publication it should be noted that the phraseology used by FISOs and Air/Ground Communication Service operators is different from that used by controllers. Examples of phraseology for Flight Information Service Officers and Air/Ground Communication Service operators may be found in Chapter 4 sections 2 and 4 respectively.

#### 1.3 Departure Information and Engine Starting Procedures


- 1.3.1 Where no ATIS is provided the pilot may ask for current aerodrome information before requesting start up.

 Stourton Ground Fastair 345, request departure information

 Fastair 345 Stourton Ground departure runway 32 wind 290 4, QNH 1008, temperature -2, dewpoint -3, RVR 550 metres

 Runway 32, QNH 1008, will call for start up Fastair 345


- 1.3.2 Requests to start engines are normally made to facilitate ATC planning and to avoid excessive fuel wastage by aircraft delayed on the ground. At certain aerodromes, along with the request, the pilot will state the location of the aircraft and acknowledge receipt of the departure ATIS broadcast identifying letter together with the QNH.

 Stourton Ground Fastair 345, stand 24 information Bravo, QNH 1022 request start up


 Fastair 345 Stourton Ground start up at time 35

- 1.3.3 When there will be a delay to the departure of the aircraft the controller will normally indicate a time to start up or expect to start up.


 Stourton Ground Fastair 345 information Charlie QNH 1022, request start up

 Fastair 345 Stourton Ground start up approved, temperature -2

or,


 Fastair 345 Stourton Ground expect start up at time 35


or,

 Fastair 345 Stourton Ground expect departure at time 49 start up at own discretion temperature -2


#### 1.4 Pushback and Powerback

At many aerodromes at which large aircraft operate, the aircraft are parked nose-in to the terminal in order to save parking space. Aircraft have to be pushed backwards by tugs before they can taxi for departure. Some aircraft also have the capability to reverse from a nose-in position to the terminal under their own power. This procedure is known as powerback. Requests for pushback or powerback are made to ATC depending on the local procedures.

 Fastair 345 stand 27 request pushback/powerback

 Fastair 345 pushback/powerback approved


or,


 Fastair 345 negative. Expect one minute delay due B747 taxiing behind


#### 1.5 Taxi Instructions

- 1.5.1 Taxi instructions issued by a controller will always contain a clearance limit, which is the point at which the aircraft must stop, unless further permission to proceed is given. For departing aircraft, the clearance limit will normally be the holding point of the runway in use, but it may be any other position on the aerodrome depending on the prevailing traffic.


















 Borton Tower G-ABCD T67 by the south side hangars request taxi for VFR flight to Walden

 G-CD taxi holding point G2 runway 24 via taxiway Charlie QNH 967 millibars

 Taxi holding point G2 runway 24 via taxiway Charlie QNH 967 millibars G-CD

 G-CD request surface wind



	 G-CD surface wind 220 6
	 G-CD request runway 14
	 G-CD follow the Seneca coming from your left taxi holding point B1 runway 14
	 Following the Seneca, taxi holding point B1 runway 14. G-CD
 Borton Tower G-ABCD T67 at the fuel station VFR to Walden request taxi	 G-CD runway 06 QNH 1008 taxi holding point B2 runway 14 via taxiway Alpha
	 QNH 1008 G-CD request taxiway Bravo, and backtrack runway 06
	 G-CD taxi holding point H1 runway 06 via taxiway Bravo
	 Taxi holding point H1 runway 06 via taxiway Bravo G-CD
 Borton Tower G-ABCD at the fuel station request taxi to flying club	 G-CD taxi holding point A1 runway 24 via Charlie
	 Taxi holding point A1 runway 24 via Charlie G-CD
	 G-CD holding point A1 runway 24 request cross
	 G-CD negative. Hold position.
	 Holding G-CD
	 G-CD taxi to the flying club, via A1 cross runway 24 report vacated
	 Taxi to the flying club cross runway 24 via A1 will report vacated G-CD



G-CD runway vacated



G-CD

- NOTES:**
- 1 Instruction to report vacated may be omitted when aerodrome control has continuous sight of the aircraft crossing.
  - 2 For helicopters the phrase "Air-taxi...." may be used in place of "Taxi...."

1.5.2 Where an ATIS broadcast is established the controller does not need to pass departure information to the pilot when giving taxi instructions. He will, however, check that the aircraft is in possession of the latest QNH.



Fastair 345 information Bravo, QNH 1020 request taxi



Fastair 345, QNH 1021, after the B747 passing left to right taxi holding point A1 runway 28



QNH 1021, after B747 taxi holding point A1 runway 28 Fastair 345

## 1.6 Pre-Departure Manoeuvring

1.6.1 Meticulous care has been taken to ensure that the phraseology which is to be employed during the pre-departure manoeuvres cannot be interpreted as a take-off clearance. This is to avoid any misunderstanding in the granting or acknowledgement of take-off clearances and the serious consequences that could result.

1.6.2 At busy aerodromes with a separate ground and tower function, aircraft are usually transferred to the tower frequency at or approaching the holding point.



Fastair 345 contact Tower 118.9



Tower 118.9 Fastair 345

1.6.3 Many types of aircraft carry out engine checks prior to departure and are not always ready for take-off when they reach the holding point.



G-CD report when ready for departure



Wilco G-CD



G-CD ready for departure

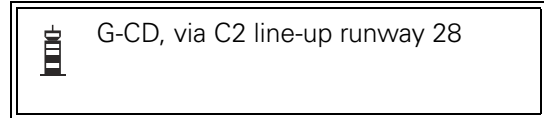
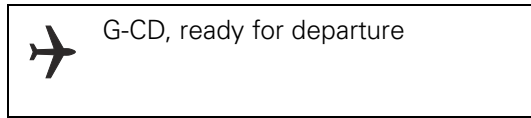


G-CD line up

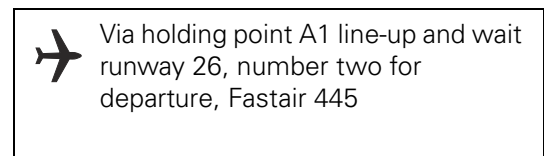
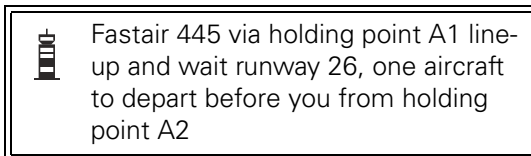


Line up G-CD

- 1.6.4 When line-up will take place at a position other than for a full-length runway departure the intermediate 'Holding Point' designator shall be included in the line-up instruction.



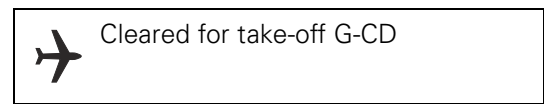
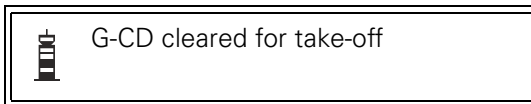
- 1.6.5 For reason of expedition, a controller may wish to line-up an aircraft for departure before conditions allow take-off.



## 1.7 Take-Off Clearance

- 1.7.1 Except in cases of emergency, messages will not be transmitted to an aircraft in the process of taking off or in the final stages of an approach and landing.

- 1.7.2 Controllers will use the following phraseology for take off.

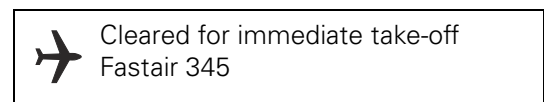
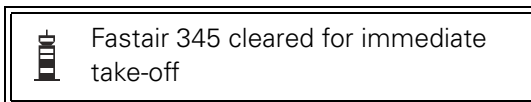


**NOTE:** The surface wind will be passed if there is a significant difference to that already passed.

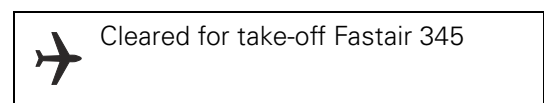
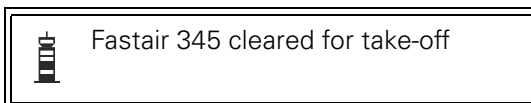
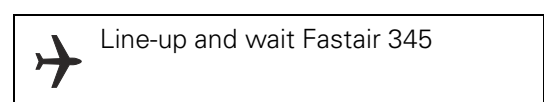
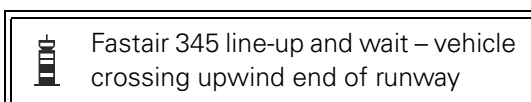
- 1.7.3 A take-off clearance shall be issued separately from any other clearance message.

- 1.7.4 For traffic reasons a controller may consider it necessary for an aircraft to take off without any delay. Therefore, when given the instruction 'cleared for immediate take-off', the pilot is expected to act as follows:






- a) At the holding point: taxi immediately on to the runway and commence take-off without stopping the aircraft.
- b) If already lined up on the runway: take-off without delay.



- 1.7.5 For reason of expedition a controller may wish to line-up an aircraft for departure before conditions allow take-off.



- 1.7.6 In poor visibility the controller may state the runway and request the pilot to report when airborne.

 Fastair 345 runway 28 cleared for take-off report airborne	 Runway 28 cleared for take-off. Wilco. Fastair 345
	 Fastair 345 airborne
	 Fastair 345 contact Radar 121.75
	 Radar 121.75 Fastair 345

- 1.7.7 Conditional phrases will not be used for movements affecting the active runway(s), except when the aircraft or vehicles concerned are seen by the controller and pilot. Conditional clearances are to relate to one movement only and, in the case of landing traffic, this must be the first aircraft on approach. A conditional instruction shall be given as follows:

- callsign;
- the condition;
- identification of subject of the condition;
- the instruction.





 Fastair 345 after the landing DC9, line up	 After the landing DC9 line up Fastair 345
--	---






- 1.7.8 When several runways are in use and/or there is any possibility that the pilot may be confused as to which one to use, the runway number will be stated.

 Fastair 345 runway 09 left cleared for take-off	 Runway 09 left cleared for take-off Fastair 345
---	---





- 1.7.9 Local departure instructions may be given prior to the take-off clearance. Such instructions are normally given to ensure separation between aircraft operating in the vicinity of the aerodrome.

- 1.7.10 Revised clearances and post departure instructions for aircraft on the runway or at the holding position shall be prefixed with an instruction to hold position.

 Fastair 345 Hold position, after departure climb straight ahead to altitude 2500 feet before turning right	 Fastair 345 Holding, after departure climb straight ahead to altitude 2500 feet before turning right.
	 Fastair 345 Cleared for take-off
	 Cleared for take-off, Fastair 345

 G-CD, after departure request right turn	 G-CD, Hold position, right turn approved
	 G-CD, Holding, right turn approved
	 G-CD, Cleared for take-off
	 Cleared for take-off, G-CD





- 1.7.11 Due to unexpected traffic developments or a departing aircraft taking longer to take-off than anticipated, it is occasionally necessary to rescind the take-off clearance or quickly free the runway for landing traffic.

 Fastair 345 take-off immediately or vacate runway	 Taking-off Fastair 345
 Fastair 345 take-off immediately or hold at the holding point	 Holding Fastair 345

- 1.7.12 When an aircraft is about to take-off or has commenced the take-off roll, and it is necessary that the aircraft should abandon take-off, the aircraft will be instructed to cancel take-off or stop immediately; these instructions will be repeated.




 G-CD hold position, cancel take-off I say again cancel take-off, acknowledge	 Holding G-CD
 Fastair 345 stop immediately I say again Fastair 345 stop immediately, acknowledge	 Stopping Fastair 345

- 1.7.13 When a pilot abandons take-off he should, as soon as practicable, inform the tower that he is doing so. Likewise, as soon as practicable, he should inform the tower of the reasons for abandoning take-off if applicable, and request further manoeuvring instructions.

 Fastair 345 stopping	 Fastair 345
	 Fastair 345 request backtrack for another departure
	 Fastair 345 backtrack approved

## 1.8 Aerodrome Traffic Circuit

- 1.8.1 Requests for circuit-joining instructions should be made in sufficient time for a planned entry into the circuit taking other traffic into account. Where ATIS is established, receipt of the broadcast should be acknowledged in the initial call to an aerodrome. When the traffic circuit is a right-hand pattern it shall be specified. A left-hand pattern **need not** be specified although it is **essential** to do so when the circuit direction is variable.




 Walden Tower G-ABCD T67 10 miles south altitude 2500 feet Wessex 1008 request joining instructions	 G-CD join righthand downwind runway 27 height 1000 feet QFE 1006
	 Join righthand downwind runway 27 height 1000 feet QFE 1006 G-CD

- 1.8.2 In some circumstances, an aircraft may be instructed to complete a standard overhead join which comprises the following:






- Overfly at 2000 ft above Aerodrome Elevation.
- If not already known, determine the circuit direction from the signals square, other traffic or windsock.
- Descend on the 'dead side' to circuit height.
- Join the circuit by crossing the upwind end of the runway at circuit height.
- Position downwind.


**NOTE:** Aerodromes with overhead joins at variance to the above standard procedure will notify such differences.


- 1.8.3 Depending on prevailing traffic conditions and the direction from which an aircraft is arriving, it may be possible to make a straight-in approach.


 Walden Tower G-ABCD T67 10 miles south altitude 2500 feet Wessex 1008 request straight in approach runway 34	 G-CD cleared straight in approach runway 34 surface wind 260 degrees 5 knots QFE 1006 report final
	 Cleared straight in approach runway 34 QFE 1006. Wilco. G-CD

- 1.8.4 The pilot having joined the traffic circuit makes routine reports as required by local procedures.


 G-CD downwind	 G-CD number 2 follow the Cherokee on base
	 Number 2, in sight Cherokee G-CD
 G-CD base	 G-CD


 G-CD final


 G-CD runway 34 cleared to land  
surface wind 270 7

 Runway 34 cleared to land G-CD

- 1.8.5 It may be necessary in order to co-ordinate traffic in the circuit to issue delaying or expediting instructions.


 G-CD extend downwind number 2  
to a Cherokee 4 miles final


 Extend downwind, number 2 G-CD

 G-CD delaying action. Orbit right  
report again on base


 Orbit right, Wilco G-CD


- 1.8.6 In order to save taxiing time when flying training in the traffic circuit pilots may wish to carry out a 'touch and go', i.e. the aircraft lands, continues rolling and takes-off, without stopping.

 G-CD downwind touch and go


 G-CD report final


 G-CD final

 G-CD runway 34 cleared touch and go  
surface wind calm


 Runway 34 cleared touch and go G-  
CD


or,

 G-CD unable to approve due traffic  
make full stop landing runway 34  
cleared to land surface wind calm

 Runway 34 cleared to land G-CD










- 1.8.7 It is helpful for circuit management purposes if a controller is informed when an aircraft which has been engaged in multiple approaches is on his last circuit.

 G-CD downwind full stop

 G-CD report final




## 1.9 Final Approach and Landing

- 1.9.1 A 'final' report is made when an aircraft has turned onto final approach. If the turn on is made at a distance greater than 4 nm from touchdown a 'long final' report is made. The landing/touch and go/low approach clearance will include the runway designation.

 G-CD final	 G-CD runway 34 cleared to land surface wind 270 7
	 Runway 34 cleared to land runway 34 G-CD
 Fastair 345 long final	 Fastair 345 report final surface wind 260 18
	 Wilco Fastair 345
	 Fastair 345 final
	 Fastair 345 runway 28 cleared to land surface wind 270 20
	 Runway 28 cleared to land Fastair 345

**NOTE:** Where established, an 'outer marker' instead of a 'final' report may be made.

- 1.9.2 The runway may be obstructed when the aircraft makes its 'final' report at 4 nm or less from touchdown but is expected to be available in good time for the aircraft to make a safe landing. On these occasions, the controller will delay landing clearance.


 G-CD final	 G-CD continue approach surface wind 270 5
	 Continue approach G-CD


The controller may or may not explain why the landing clearance has been delayed but the instruction to 'continue' IS NOT an invitation to land and the pilot must wait for landing clearance or initiate a missed approach (see Chapter 4, paragraph 1.10.3).

- 1.9.3 A landing aircraft may be permitted to touch down before a preceding landing aircraft which has landed and vacated the runway provided that:
- the runway is long enough to allow safe separation between the two aircraft and there is no evidence to indicate that braking may be adversely affected;
  - it is during daylight hours;





- c) the controller is satisfied that the landing aircraft will be able to see the preceding aircraft which has landed, clearly and continuously, until it has vacated the runway; and
- d) the pilot of the following aircraft is warned. (Responsibility for ensuring adequate separation rests with the pilot of the following aircraft.)


 Fastair 345, runway 28, land after the B737, surface wind calm

 Land after the B737 Fastair 345

- 1.9.4 A pilot may request to fly past the control tower or other observation point for the purpose of visual inspection from the ground.
- 1.9.5 If the low pass is made for the purpose of observing the undercarriage, one of the following replies could be used to describe its condition but these examples are not exhaustive:
- a) landing gear appears down;
  - b) right (or left, or nose) wheel appears up (or down);
  - c) wheels appear up;
  - d) right (or left, or nose) wheel does not appear up (or down).
- 1.9.6 For training purposes, a pilot may request permission to make an approach along, or parallel to the runway, without landing.


 Fastair 345 request low approach for training


 Fastair 345 cleared low approach runway 28 not below 400 feet above threshold elevation report final

 Cleared low approach runway 28 not below 400 feet above threshold elevation Wilco Fastair 345

## 1.10 Missed Approach


- 1.10.1 Instructions to carry out a missed approach may be given to avert an unsafe situation. When a missed approach is initiated cockpit workload is inevitably high. Any transmissions to aircraft going around shall be brief and kept to a minimum.


 Fastair 345 go around I say again go around acknowledge

 Going around Fastair 345

- 1.10.2 An aircraft on an instrument approach is to carry out the published missed approach procedure and an aircraft operating VFR is to continue into the normal traffic circuit unless instructions are issued to the contrary.

- 1.10.3 In the event of missed approach being initiated by the pilot, the phrase 'going around' shall be used.













 G-CD going around

 G-CD Roger

- 1.10.4 At military aerodromes 'GO AROUND' is also employed to instruct an aircraft to fly another circuit. Unless otherwise instructed, circuit height should be maintained (or regained) and a 'Deadside' call made before turning Crosswind to report Downwind.




## 1.11 Runway Vacating and Communicating After Landing


- 1.11.1 Unless absolutely necessary, controllers will not give taxi instructions to pilots until the landing roll is complete. Unless otherwise advised, pilots should remain on tower frequency until the runway is vacated.


 Fastair 345 vacate left	 Vacate left Fastair 345
 Fastair 345 when vacated contact Ground 118.35	 When vacated Ground 118.35 Fastair 345
	 Kennington Ground Fastair 345 runway vacated
	 Fastair 345 Kennington Ground taxi to Stand 27 via taxiway Alpha
	 Taxi to Stand 27 via taxiway Alpha Fastair 345
 G-CD taxi to the end report runway vacated	 Taxi to the end, Wilco G-CD
	 G-CD runway vacated
	 G-CD taxi to the flying club
	 Taxi to the flying club G-CD


## 1.12 Essential Aerodrome Information

Essential Aerodrome Information is information regarding the manoeuvring area and its associated facilities which is necessary to ensure the safe operation of aircraft. Essential Aerodrome Information is passed to aircraft whenever possible prior to start-up or taxi and prior to the commencement of final approach.

 Fastair 345 caution construction work at the end of Stand 37
 ... caution work in progress ahead north side of taxiway Alpha
 ... caution centre line taxiway lighting unserviceable

 ... caution PAPIs runway 27  
unserviceable

 ... caution large flock of birds north of  
runway 27 near centre taxiway

 ... message from aerodrome  
authority, fire and rescue services  
reduced. The aerodrome can only  
accept aircraft up to and including  
category (number)

## 2 Aerodrome Flight Information Service Phraseology

### 2.1 Introduction

- 2.1.1 Concise and unambiguous phraseology used at the correct time is vital to the smooth, safe and expeditious running of an aerodrome and associated ATZ. It is not only the means by which instructions and information are passed but it also assists pilots in maintaining an awareness of other traffic in their vicinity, particularly in poor visibility conditions.
- 2.1.2 Messages will not be transmitted to an aircraft during take-off, the last part of final approach or the landing roll, unless it is necessary for safety reasons, because it will be distracting to the pilot at a time when the cockpit workload is often at its highest.
- 2.1.3 Local procedures vary from aerodrome to aerodrome and it is impossible to give examples to cover every situation which may arise at the multiplicity of different types of aerodrome. Information in addition to that shown in the examples, e.g. time checks, etc. may be provided as necessary.

### 2.2 Type of Service




















- 2.2.1 As described in Chapter 2 the type of service provided at an aerodrome falls into one of three categories. In this section the examples are confined to those used by Flight Information Service Officers (FISO). Phraseology for air traffic controllers may be found in Chapter 4 section 1 and that for Air/Ground Communication Service Operators in Chapter 4 section 4.
- 2.2.2 Whilst the RTF procedures used by air traffic controllers form the main content of this publication it should be noted that the phraseology used by FISOs is different from that used by controllers. Flight Information Service (FIS) provided at an aerodrome is a service to give information useful for the safe and efficient conduct of flights in the Aerodrome Traffic Zone. From the information received pilots will be able to decide the appropriate course of action to be taken to ensure the safety of flight. Generally, the Flight Information Service Officer is not permitted to issue instructions or advice to pilots of his own volition. However, in granting or refusing permission under Rule 35 and 36 of the Rules of the Air, FISOs at aerodromes are permitted to pass instructions to vehicles and personnel operating on the manoeuvring area and information and instructions to aircraft moving on the apron and specific parts of the manoeuvring area. Elsewhere on the manoeuvring area and at all times in the air, information only shall be passed to pilots. Further details on the passing of instructions by FISOs at aerodromes are contained in CAP 410 Part B Aerodromes.
- 2.2.3 FIS is available at aerodromes during the hours of operation indicated in the UK AIP. The service is easily identifiable by the callsign suffix 'INFORMATION'.
- 2.2.4 FISOs are also permitted to pass messages on behalf of other agencies and instructions from the aerodrome operator. If they do so, they will include the name of the agency so that pilots will be aware that the message comes from a legitimate source, e.g. 'Wrayton Control clears you to join ...'.
- 2.2.5 With the exception of issuing instructions to aircraft on the ground as described in section 3, FISOs are reminded that the service they provide is an information service relating to the ATZ and aerodrome. They must ensure that the information given to pilots is distinct and unambiguous, as pilots will use this information for the safe and efficient conduct of their flights.

- 2.2.6 A FISO may request pilots to make position reports e.g. downwind, final etc. These requests do not have the status of instructions, although it is expected that most pilots will comply.
- 2.2.7 From the instructions and information provided by the FISO to aircraft on the appropriate areas of the aerodrome, the pilot will be able to determine if it is safe to taxi. From the information provided by the FISO, the pilot will determine if it is safe to land, take-off or transit the ATZ. FISOs are not permitted to refuse entry into the ATZ when requested by a pilot. The aerodrome authority may decide that they will not permit an aircraft to land at their aerodrome and request that the FISO pass this message on. Such a message must be prefixed: 'Message from the aerodrome authority...' FISOs may **not** issue such messages of their own volition.
- 2.3 **AFIS Phraseology for Ground Movement, Take-off, Landing and Transit**
- 2.3.1 RTF messages transmitted on aviation VHF frequencies should normally comprise callsign and text as described earlier in this document.
- 2.3.2 Ground movement instructions are similar for aircraft, vehicles and tractors towing aircraft but the operative word in the message is 'taxi', 'proceed' and 'tow' respectively.

	Phraseology
Taxi Instructions prior to take off, after landing and other ground movement.	<p>(Aircraft callsign) taxi holding point (designation) runway (designation) via (route), surface wind (number) degrees (number) knots, QNH/QFE (pressure) millibars, left/right hand circuit.</p> <p>(Aircraft callsign) taxi to stand (designation) via (route).</p> <p>(Aircraft callsign) taxi to (location).</p> <p>When necessary, detailed taxiing instructions e.g. turn left from the apron and take the first intersection right.</p> <p>(Aircraft callsign) after the (aircraft type) passing (e.g. left to right) taxi holding point (designation) runway (designation) surface wind (number) degrees (number) knots, QNH/QFE (pressure) millibars, left/right hand circuit.</p> <p>(Aircraft callsign) follow the (aircraft type) (position of aircraft).</p> <p>(Aircraft callsign) hold position.</p> <p><b>Note:</b> FISOs are permitted to pass instructions to helicopters engaged in air taxiing. However, when the pilot reports ready to depart, the FISO shall pass information. For all inbound helicopters, information shall be passed until they land or reach the hover prior to air taxiing to the parking area. Thereafter, instructions shall be given until the helicopter touches down.</p>
Aircraft at the holding point of runway to be used for departure ready for take-off	<p>(Aircraft callsign) hold position.</p> <p>(Aircraft callsign) take off at your discretion, surface wind (number) degrees (number) knots.</p> <p>(Aircraft callsign) traffic is (traffic information) take off at your discretion, surface wind (number) degrees (number) knots.**</p> <p><b>**Note:</b> Pilots will notify the FISO of their intentions.</p>

Aircraft at the holding point of runway to be used for departure ready for take-off with the possibility of requiring a backtrack	(Aircraft callsign) do you require to backtrack the runway? ** <b>**Note:</b> Pilots will notify the FISO of their intentions.
Aircraft requiring a backtrack	(Aircraft callsign) report entering the runway. (Aircraft callsign) report lining up. ** (Aircraft callsign) traffic is (traffic information) report entering the runway and lining up. ** (Aircraft callsign) the runway is occupied (details of traffic). Report lining up. ** (Aircraft callsign) the (aircraft type) has landed to vacate and there is a (aircraft type) on a 2 mile final. Report lining up. ** (Aircraft callsign) backtrack as required, surface wind (number) degrees (number) knots, take off at your discretion. ** <b>**Note:</b> Pilots will notify the FISO of their intentions.
Instructions for crossing runway in use	(Aircraft callsign) cross runway (designation) at (point of crossing). Report vacated.* (Aircraft callsign) cross, report vacated.* (Aircraft callsign) negative, hold position, I will call you. *‘Report vacated’ instructions may be omitted when the FISO has continuous sight of the vehicle or aircraft crossing.
When airborne	(Aircraft callsign) roger, report (downwind or position).
Aircraft wishes to transit the ATZ	(Aircraft callsign) (traffic and aerodrome information), report entering/overhead/leaving.
Aircraft wishes to enter the ATZ for landing	(Aircraft callsign) runway (designation) left/right hand circuit, surface wind (number) degrees (number) knots, QNH/QFE (pressure) millibars (traffic information and essential aerodrome information as appropriate).
Aircraft reports joining the circuit	(Aircraft callsign) roger, (traffic information) report downwind/base/final.
Aircraft reports final	<i>(If number 1 and runway is clear)</i> (Aircraft callsign) land/touch and go at your discretion, surface wind (number) degrees (number) knots. OR <i>(If aircraft has traffic ahead on final)</i> (Aircraft callsign) roger, (number) aircraft ahead on final. OR <i>(If the runway is occupied)</i> (Aircraft callsign) the runway is occupied (traffic information).
Aircraft expects Air Traffic Control Service	(Aircraft callsign) no ATC Service available. Flight Information Service only.

2.3.3 An example of a typical FISO/Pilot RTF exchange is detailed below.

 G-ABCD, ready to taxi	 G-CD, taxi holding point C2, runway 06 via taxiway C, surface wind 060 10 knots, QNH 998 millibars, left hand circuit
	 Roger, taxi to holding point C2, runway 06 via taxiway C, QNH 998 millibars G-CD
at the holding point...	
 G-CD, C2 Ready for departure	 G-CD, Hold position
	 Holding G-CD
When the runway is available...	
 G-CD, Traffic is a PA28 late downwind, take-off at your discretion, surface wind 050 13 knots	 Roger, taking-off G-CD
	 G-CD, Roger, report downwind
 G-CD, Downwind to land	 G-CD, Roger, traffic is a Cessna 172 base leg, report final
	 Wilco G-CD
 G-CD, Final	 G-CD, Roger, Cessna 172 ahead on final
	 Roger G-CD
When the runway is available...	
 G-CD, Land at your discretion, surface wind 050 10 knots	 Roger G-CD
 G-CD, Roger, after the Cessna 172 taxiing right to left, taxi to the aero club, via taxiway C	 Roger, after the Cessna 172, taxi to the aero club, via taxiway C G-CD

After landing...

### 3 Aerodrome Phraseology for Helicopters

#### 3.1 Introduction

- 3.1.1 Rotary-wing flight characteristics mean that helicopter operations at aerodromes can differ significantly from fixed-wing operations. This section describes standard phraseology and procedures to address the different requirements for helicopter lifting, taxiing, taking-off, and landing (including the approach and departure phases), particularly at aerodromes where rotary-wing and fixed-wing operations are integrated.
- 3.1.2 Standard phraseology should be used in all situations for which it is specified. When standardised phraseology cannot serve an intended transmission, plain language should be used. The use of plain language may further assist when describing rotary-wing aircraft manoeuvres. Care should be exercised to ensure that all parties involved achieve clear understanding.
- 3.1.3 The phraseology described in this section is intended for general use. However, the examples of taxiing phraseology describe communications specific to aerodromes at which ATC or AFIS is provided. Phraseology examples for take-off and landing are specific to communications at aerodromes with ATC.

#### 3.2 Helicopter Callsigns

- 3.2.1 Aircraft callsigns to be used are described in Chapter 2 paragraph 1.8. Provision is made for the name of the aircraft manufacturer, or the aircraft model, to be used before the aircraft registration (in full or abbreviated form). If considered appropriate, the pilot or ATSU may replace manufacturer's name or aircraft model with the term 'Helicopter' where this may benefit the ATSU or other aircraft (see phraseology examples paragraphs 3.6.4 and 3.6.5).

**Table 12**

Full callsign	Abbreviation
Helicopter G-ABCD	Helicopter CD

#### 3.3 Helicopter Phraseology for Taxiing

- 3.3.1 These procedures are for helicopters taxiing for departure, or after landing, or for general manoeuvring on the aerodrome. Phraseology and procedures for specific manoeuvring on the aerodrome, for example for training purposes, should be described in local procedures.
- 3.3.2 The term 'LIFT' shall describe a manoeuvre where the helicopter gets airborne and enters a 'HOVER'.
- 3.3.3 'HOVER' describes a manoeuvre where the helicopter holds position whilst airborne in ground effect, waiting to proceed. Hover allows spot/axial turns (i.e. about the central axis of the helicopter). When required, further instructions should subsequently be transmitted to permit the helicopter to proceed.
- 3.3.4 The term 'AIR TAXI' shall be used when it is necessary for a helicopter to proceed at a slow speed above the surface, normally below 20 knots and in ground effect (ICAO).
- 3.3.5 The instruction 'GROUND TAXI' shall be used for the movement of a helicopter, in contact with the surface of the aerodrome, under its own power. This could be required for a helicopter fitted with wheels, to reduce rotor downwash (ICAO).



- 3.3.6 An instruction to 'TAXI' leaves the pilot free to select the most appropriate method, either ground taxi or air taxi. Pilots and controllers should use the term AIR TAXI or GROUND TAXI when required to differentiate between air taxiing and ground taxiing (for helicopters equipped with wheels).

**NOTE 1:** Air taxiing helicopters at aerodromes where ATC and AFIS are provided will be issued with detailed taxi routes and instructions as appropriate to prevent collisions with other aircraft and vehicles. Helicopters are expected to follow procedures/routes on aerodromes appropriate to aeroplanes unless otherwise authorised.

**NOTE 2:** ATC and AFIS units will normally avoid issuing instructions that result in taxiing helicopters coming into close proximity with small aircraft or helicopters and will normally give consideration to the effect of turbulence from taxiing helicopters on arriving and departing light aircraft (ICAO).


- 3.3.7 For a helicopter taxiing, the instruction 'HOLD' shall indicate a requirement to come to a standstill.
- 3.3.7.1 A helicopter air taxiing and instructed to 'HOLD', may hold in the hover or may touch down and hold on the ground at the pilot's discretion. If touch down is not authorised, a helicopter may be instructed by the ATSU to 'HOLD IN THE HOVER'.
- 3.3.7.2 A helicopter ground taxiing and instructed to 'HOLD' shall hold on the ground, unless a hover manoeuvre is specifically authorised or requested by the ATS unit.
- 3.3.8 ATC and AFIS will normally avoid issuing a frequency change instruction to a single-pilot helicopter hovering or air taxiing. If required and whenever possible, control instructions from the next ATS unit will be relayed until the pilot is able to change frequency (ICAO).


#### 3.4 **Helicopter Phraseology for Take-Off and Landing (ATC Only)**


- 3.4.1 At aerodromes, helicopter take-offs and landings may not be restricted to designated runways or landing areas. With appropriate permission helicopters may take-off and land at any location on the aerodrome. At aerodromes with an air traffic control service, all movements are subject to the permission of the ATC unit.
- 3.4.2 At aerodromes with air traffic control service, when helicopters land or take-off on the manoeuvring area, and within sight of the VCR the terms 'CLEARED TO LAND' and 'CLEARED FOR TAKE-OFF' shall be used to authorise the manoeuvres.
- 3.4.3 At aerodromes with air traffic control service, when helicopters land or take-off at locations not on the manoeuvring area (e.g. apron, maintenance area, sites adjacent the aerodrome), or locations not in sight of the VCR, or unlit locations at night, the appropriate phrase 'LAND AT YOUR DISCRETION' or 'TAKE-OFF AT YOUR DISCRETION' shall be used to authorise the manoeuvres. Relevant traffic information on other aircraft (airborne or on the ground) shall also be passed.
- 3.4.4 The term 'TOUCH DOWN' shall be used to describe an aircraft (helicopter or fixed-wing) coming into contact with the surface in accordance with normal operation. A clearance to land leaves the pilot of a helicopter free to either enter a low hover, or to touch down, as appropriate.

### 3.5 Helicopter Taxiing Phraseology Examples (ATC and AFIS Only)


#### 3.5.1 Taxi Instruction


 Borton Tower, G-ABCD, request TAXI for departure runway 06

 G-ABCD, Borton Tower, TAXI holding point H1, runway 06, via taxiway Golf

 TAXI holding point H1 runway 06 via taxiway Golf, G-ABCD  
*Note: The use of 'taxi' indicates the pilot is free to air taxi or ground taxi at his/her discretion*

#### 3.5.2 Air Taxi Instruction (if required)


 Borton Tower, G-ABCD, request AIR TAXI for departure runway 06


 G-CD, Borton, AIR TAXI holding point H1, runway 06, via taxiway Golf

 AIR TAXI holding point H1 runway 06 via taxiway Golf, G-CD

### 3.6 Helicopter Take-Off and Landing Phraseology Examples (ATC only)


#### 3.6.1 Take-Off on the Runway


 G-CD, ready for departure

 G-CD, Runway 06, CLEARED FOR TAKE-OFF

 CLEARED FOR TAKE-OFF, G-CD

#### 3.6.2 Landing on the Runway

 G-CD, final runway 06

 G-CD, Runway 06, CLEARED TO LAND, surface wind 060 10

 CLEARED TO LAND, G-CD




#### 3.6.3 Take-Off from a designated Helicopter Landing Area on the Manoeuvring Area

 G-CD, 'Area Whiskey' ready for departure




 G-CD, 'Area Whiskey' CLEARED FOR TAKE-OFF

 CLEARED FOR TAKE-OFF, G-CD







## 3.6.4 Landing at a designated Helicopter Landing Area on the Manoeuvring Area.

 G-ABCD, at the Power Station to land 'Area Whisky'	 G-CD, 'Area Whisky' CLEARED TO LAND, surface wind 060 10
 CLEARED TO LAND, 'Area Whisky' G-CD	

## 3.6.5 Take-Off from the Apron (or location not on the Manoeuvring Area) for a Direct Departure (i.e. not following the visual circuit for departure).

 Borton Tower, Helicopter G-ABCD, beside the south side hangars ready for direct departure to Walden	 Helicopter CD, Borton, direct departure, surface wind 060 10, QNH 997 millibars, no reported traffic, TAKE-OFF AT YOUR DISCRETION
 TAKING-OFF, departing direct, QNH 997 millibars, Helicopter CD	

## 3.6.6 Direct Arrival to the Apron (or location not on the Manoeuvring Area) for Landing.

 Borton Tower, Helicopter G-ABCD, 5 miles east inbound to land Eastern Apron	 Helicopter CD, Borton, route to the eastern apron via the Power Station, report at the Power Station wind 060 10 QNH 997 millibars, runway 06 in use
 Route to Eastern Apron via the Power Station, wilco, QNH 997 millibars, Helicopter CD	
 Helicopter CD, at the Power Station	 Helicopter CD, traffic is a C172 taxiing from Stand 8 for taxiway B, LAND AT YOUR DISCRETION, surface wind 060 10
 ROGER, Landing Eastern Apron, Helicopter CD	

## 4 Aerodrome Phraseology for Vehicles (ATC and AFIS only)

### 4.1 Introduction

4.1.1 The expeditious movement of vehicles plays an essential supporting role in the operation of an aerodrome. Whenever possible the areas in which vehicles and aircraft operate are segregated. However, there are many occasions when vehicles need to move on the manoeuvring area either for maintenance purposes or in direct support of aircraft operations.

4.1.2 Procedures governing the movement of vehicles vary widely from aerodrome to aerodrome, but certain factors to be taken into account when driving on an aerodrome are common to all:

- a) in general, aircraft are by no means as manoeuvrable as ground vehicles;
- b) the visibility from an aircraft cockpit for ground movement purposes is often restricted compared with a vehicle.

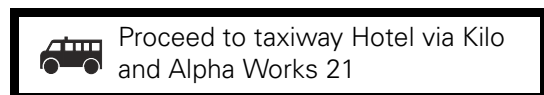
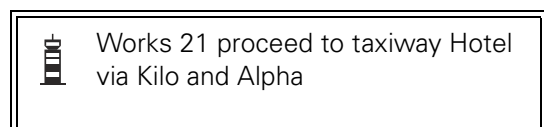
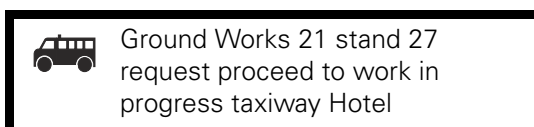
Therefore when vehicles are operating in close proximity to aircraft, drivers should be extremely vigilant and comply with Rule 36/37 of the Rules of the Air and, if applicable, ATC instructions.

4.1.3 Correct RTF operating technique must be observed by all users. For all vehicles on the movement area, it is important that a continuous listening watch is maintained, not only in case of further instructions or information from the tower, but also so that drivers can be aware of the movements, and intended movements, of other traffic thereby reducing the risk of confliction.

4.1.4 **The examples that follow are applicable to air traffic controllers and FISOs only. Air/Ground Communication Service operators are not to pass instructions and must use the phraseology they would use for the movement of aircraft on the aerodrome.**


### 4.2 Movement Instructions


4.2.1 Drivers on first call should identify themselves by their vehicle call sign, state their position and intended destination (and possibly required route).




4.2.2 If the controller is too busy he will reply 'standby'. This means that the driver should wait until the controller calls back. The driver shall **not** proceed until permission is given.

4.2.3 When there is conflicting traffic the controller may reply 'hold position'. This means that the driver shall not proceed until the controller calls back with permission. All other replies should contain a clearly defined point to which the driver may proceed; this may or may not be the intended destination. If it is not the intended destination drivers must stop at this point and further permission shall be requested.


 Ground Tels 5 at Charlie 8 request proceed to hangar 3


 Tels 5 proceed holding point C1 runway 14


 Proceeding holding point C1 runway 14 Tels 5

**NOTE:** The vehicle has only been cleared as far as the holding position to await runway crossing clearance and permission to proceed to hangar 3.

- 4.2.4 Permission to proceed on the apron may include instructions to ensure safe operations.

 Ground Tug 5 stand 21 request proceed to gate 26


 Tug 5 after the Fastair BAe 146 on your right has passed, proceed to stand 26, caution jet blast


 After the BAe 146 has passed proceed stand 26, Tug 5


### 4.3 To Cross a Runway


- 4.3.1 Drivers should note carefully the position to which they may proceed, particularly where the intended route involves crossing a runway. Some aerodromes may have procedures that will allow vehicles to proceed to a holding point on the movement area and then request runway crossing instructions. Under no circumstances shall a driver cross a runway unless **positive permission has been given and acknowledged**. A runway vacated report should not be made until the vehicle (and tow) is clear of the designated runway area.


- 4.3.2 In order to prevent unauthorised runway incursions, when an ATS Unit issues an instruction to cross a runway, the appropriate holding point designator shall be included in the instruction. A vehicle driver should query any instruction that identifies a holding point designator inconsistent with the vehicle location, or the driver's request, before proceeding onto the runway.

 Ground Works 21 by the control tower request proceed to maintenance base


 Works 21 proceed holding point A2 runway 32 via Alpha and Bravo


 Proceeding holding point A2 runway 32 via Alpha and Bravo Works 21

 Works 21 holding point A2 runway 32 request cross


 Works 21 hold position


 Holding Works 21


 Works 21 via A2 cross runway 32 proceed to maintenance base via Foxtrot


 Crossing via A2 runway 32 proceeding to maintenance base via Foxtrot Works 21

- 4.3.3 If a vehicle is operating on the runway, it will be instructed to vacate the runway when it is expected that an aircraft will be landing or taking off.


 Works 21 vacate runway 27 take next right, report vacated


 Vacate next right, Wilco Works 21

 Works 21 runway 27 vacated

 Works 21


- 4.3.4 When a vehicle is moving on the movement area it may be necessary to inform the vehicle of a potentially dangerous situation and to tell it to stop.


 Works 21 stop immediately aircraft crossing ahead


 Stopping Works 21

#### 4.4 Vehicles Towing Aircraft

Drivers of vehicles required to tow aircraft should not assume that the receiving station is aware that an aircraft is to be towed. The performance and manoeuvrability of ground vehicles is obviously considerably reduced when towing aircraft and this is taken into account when instructions to such vehicles are issued. Therefore, in order to avoid any confusion, and as an aid to identification, drivers should state the type, and where applicable the operator, of the aircraft to be towed in the first call.

 Ground Tug 9 request tow Fastair BAe 146 from stand 25 to maintenance hangar 3

 Tug 9, tow approved from stand 25 to maintenance hangar 3 via Echo

 Tow to maintenance hangar 3 via Echo Tug 9

## **5 Aerodrome Air/Ground Communication Service Phraseology**

### **5.1 Introduction**

- 5.1.1 Concise and unambiguous phraseology used at the correct time is vital to the smooth, safe and expeditious running of an aerodrome and associated ATZ. It is not only the means by which information is passed but it also assists pilots in maintaining an awareness of other traffic in their vicinity, particularly in poor visibility conditions.
- 5.1.2 Messages will not be transmitted to an aircraft during take-off, the last part of final approach or the landing roll, unless it is necessary for safety reasons, because it will be distracting to the pilot at a time when the cockpit workload is often at its highest.
- 5.1.3 Local procedures vary from aerodrome to aerodrome and it is impossible to give examples to cover every situation which may arise at the multiplicity of different types of aerodrome. Information in addition to that shown in the examples, e.g. time checks, etc. may be provided as necessary.

### **5.2 Type of Service**

- 5.2.1 As described in Chapter 2 the type of service provided at an aerodrome falls into one of three categories. In this section the examples are confined to those used by Air/Ground Communication Service operators.
- 5.2.2 Whilst the RTF procedures used by air traffic controllers and FISOs form the main content of this publication it should be noted that the phraseology used by Air/Ground Communication Service operators is different from that used by controllers and FISOs. This section describes only the phraseology provided by AGCS operators and details of the service itself may be found in CAP 452 Aeronautical Radio Station Operator's Guide on the CAA web site or from Documedia Solutions Ltd. Phraseology for aerodrome air traffic controllers may be found in Chapter 4 section 1 and that for FISOs in Chapter 4 section 2.
- 5.2.3 An AGCS radio station operator is not necessarily able to view any part of the aerodrome or surrounding airspace. Traffic information provided by an AGCS radio station operator is therefore based primarily on reports made by other pilots. Information provided by an AGCS radio station operator may be used to assist a pilot in making decisions, however, the safe conduct of the flight remains the pilot's responsibility.

### **5.3 Air/Ground Station Identification**

Radio operators must ensure that the full callsign, including the suffix 'RADIO', is used in response to the initial call from an aircraft and on any other occasion that there is doubt.

### **5.4 Phraseology and Examples**

- 5.4.1 From time to time air traffic controllers and flight information service officers are invited by aerodrome authorities to provide an Air/Ground Communication Service. They are permitted to do so in certain circumstances provided they hold a valid Certificate of Competence (CA 1308). However, air traffic controllers, in particular, must appreciate that there is a considerable difference between the service they normally provide and the Air/Ground Communication Service. Therefore they must be careful not to lapse into providing an air traffic control service.
- 5.4.2 Personnel providing an Air/Ground Communication Service must ensure that they do not pass a message which could be construed to be either an air traffic control instruction or an instruction issued by FISOs for specific situations. Clearances

initiated by an air traffic control unit may be relayed but the name of the authority must be included in the message, e.g:





'London control clears you to join controlled airspace . . . '

**NOTE:** Air Traffic Control clearances passed to radio operators to be issued on behalf of the ATC unit are to be read back in full to the issuing authority. The pilot is to readback, in full, the clearance relayed by the Air/Ground Communication Service operator.

















Event	Response
A/C ready to taxi	(Aircraft callsign) runway (designation) left/right hand circuit wind number (degrees) number (knots) QFE/QNH (pressure) millibars.
A/C wishes to cross a runway	(Aircraft callsign) (traffic information e.g. no reported traffic or, after the (aircraft type) has landed no reported traffic).
A/C ready to take off	(Aircraft callsign) no reported traffic (or traffic is...) surface wind (number) degrees (number) knots.
A/C reports airborne	(Aircraft callsign) roger
A/C overflying reports entering ATZ or asks for traffic information	(Aircraft callsign) (traffic information) (aerodrome information)
A/C requests joining information for a landing	(Aircraft callsign) runway (designation) left/right hand circuit surface wind (number) degrees (number) knots, QFE/QNH (pressure) millibars (traffic information).
A/C reports joining circuit	(Aircraft callsign) roger, (plus, when applicable, updated traffic information and any changes to aerodrome information).
A/C reports landed and/or runway vacated	(Aircraft callsign) (any appropriate aerodrome information).




















**NOTE:** Air ground operators must not use the expression 'at your discretion' as this is associated with the service provided by FISOs and is likely to cause confusion to pilots.

5.4.3 An example of a typical RTF exchange is detailed below:

	Seaton Radio G-ABCD radio check 123.0 and taxi information		G-ABCD Seaton Radio readability 5 runway 23 left hand circuit QNH 1022
	G-ABCD readability 5 also, taxiing for runway 23 left hand QNH 1022		
	G-CD Roger		



 G-CD ready for departure	 G-CD roger. No reported traffic, surface wind 230 degrees 10 knots
	 Roger taking off G-CD
or,	
 G-CD traffic is a Cherokee reported final, surface wind 230 degrees 10 knots	 Roger taking off G-CD
	or,
	 Roger holding position G-CD
once Cherokee has landed and vacated	
 G-CD lining-up and taking off	 G-CD roger surface wind 230 degrees 10 knots
	 G-CD leaving the circuit to the west. Will report when re-joining
	 G-CD roger two other aircraft known to be operating VFR to the west
	 Roger G-CD
 Seaton Radio G-BCDA request traffic information	 G-BCDA Seaton Radio pass your message
	 G-BCDA PA28 from Westbury to Millom position overhead Marlow, 1800 feet on QNH 1021, estimate Seaton at 15
	 G-DA, roger. Runway 23 is active left hand with a Cessna 172 reported downwind QNH 1022
	 QNH 1022 will report overhead G-DA

 G-DA overhead at 15 will report leaving the frequency	 G-DA roger
	 G-DA now leaving the ATZ changing to Wrayton information 124.75
	 G-DA roger
 Seaton Radio G-ABCD 6 miles west of Seaton request airfield information	 G-CD Seaton runway 23 left hand, QFE 1021. Traffic is a Cessna 172 reported left base
	 Roger. Runway 23 left hand circuit, QFE 1021 G-CD
 G-CD overhead joining for runway 23	 G-CD roger no reported traffic
or,	
 G-CD downwind	 G-CD roger no reported traffic
 G-CD final	 G-CD roger surface wind 220 15. Traffic is a Cessna 172 reported lining up to depart
	 Roger G-CD
 G-CD vacating left and returning to the club	 G-CD roger
 G-CD ready to cross runway 15	 G-CD roger no reported traffic
	 Roger G-CD

## 5.5 Offshore Communication Service

### 5.5.1 Introduction

Aeronautical radio stations located offshore on rigs, platforms and vessels provide an air-ground service to helicopters operating in the vicinity.

### 5.5.2 Offshore Station Identification

Offshore radio stations must identify themselves using the callsign specified by the CAA in the approval document.

### 5.5.3 Offshore Phraseology

Actual communications will follow a pattern dictated by the individual circumstances. However, in the interests of conformity and to avoid misunderstandings, a selection is given of the types of messages a helicopter pilot may pass, their meaning where necessary and the response which should be made.

Helicopter	Response
(Offshore station callsign) (Aircraft callsign) Take the Flight Watch (You are requested to maintain radio watch until watch is taken by another station)	(Aircraft callsign) (Offshore station callsign) I have the Flight Watch
(Offshore station callsign) (Aircraft callsign) position ...	(Aircraft callsign) (Offshore station callsign) Roger
(Offshore station callsign) (Aircraft callsign) Report your weather	(Aircraft callsign) (Offshore station callsign) Weather <i>(State the following information as appropriate)</i> Surface Wind (number) degrees (number) knots, Visibility (distance) kilometres/metres, Weather (rain, snow, showers, etc.), Cloud few/scattered etc., (number) feet estimated, Ambient temperature (number), Helideck temperature (number), (Name of Area) QNH (pressure) (millibars), QFE (pressure) (millibars), Pitch (number) degrees: Roll (number) degrees: Heave (number) metres <i>(as appropriate)</i>
(Offshore station callsign) (Aircraft callsign) Switch on the NDB	(Aircraft callsign) (Offshore station callsign) Wilco NDB frequency (number) kHz ident (letters) <i>(if requested)</i>
(Offshore station callsign) (Aircraft callsign) ETA is (time)	(Aircraft callsign) (Offshore station callsign) Roger
(Offshore station callsign) (Aircraft callsign) Landing in (number) minutes	(Aircraft callsign) (Offshore station callsign) Roger
(Offshore station callsign) (Aircraft callsign) overhead	(Aircraft callsign) (Offshore station callsign) Roger
(Offshore station callsign) (Aircraft callsign) Beacon outbound <i>(this indicates the pilot is using the NDB as a navigational aid to take him from overhead to a point where he can safely descend below cloud and return under visual conditions to the helideck)</i>	(Aircraft callsign) (Offshore station callsign) Roger
(Offshore station callsign) (Aircraft callsign) Is the deck available for landing?	(Aircraft callsign) (Offshore station callsign) Affirm Deck available (for landing) <i>or</i> Deck obstructed, expect (number) minutes delay, <i>or</i> Deck closed due to (reason), expect (number) minutes delay <i>Note: Transmission of 'for landing' is optional</i>

<b>Helicopter</b>	<b>Response</b>
(Offshore station callsign) (Aircraft callsign) Ready for departure	(Aircraft callsign) (Offshore station callsign) Roger <i>(or pass relevant information)</i>
(Offshore station callsign) (Aircraft callsign) Departing	(Aircraft callsign) (Offshore station callsign) Roger
(Offshore station callsign) (Aircraft callsign) Switch off the NDB	(Aircraft callsign) (Offshore station callsign) Wilco
(Offshore station callsign) (Aircraft callsign) Radio contact with (ATS Unit), close down the Flight Watch	(Aircraft callsign) (Offshore station callsign) Closing down Flight Watch
<b>Additionally the following are applicable to vessels:</b>	
(Vessel callsign) (Aircraft callsign) Report position	(Aircraft callsign) (Vessel callsign) Position (lat/long)
(Vessel callsign) (Aircraft callsign) Report course and speed	(Aircraft callsign) (Vessel callsign) Course and speed (number) degrees (number) knots
(Vessel callsign) (Aircraft callsign) Report relative wind (Relative to the ship's heading)	(Aircraft callsign) (Vessel callsign) Relative wind Port/Starboard (number) degrees (number) knots
(Vessel callsign) (Aircraft callsign) Maintain course and speed	(Aircraft callsign) (Vessel callsign) Roger
(Vessel callsign) (Aircraft callsign) Alter course Port/Starboard (number) degrees	(Aircraft callsign) (Vessel callsign) Standby. Course now (number) degrees
(Vessel callsign) (Aircraft callsign) Change speed to (number) knots	(Aircraft callsign) (Vessel callsign) Standby. Speed now (number) knots

**NOTE: 1** The phrase 'Deck available (for landing)' replaces the previously used phrase, 'Deck is clear for landing', in order to avoid any possible confusion with a landing clearance that may be issued by an Air Traffic Control unit. For operational purposes, the two terms should be considered to have the same meaning.

**NOTE: 2** Procedures for certain messages (e.g. when following the requirements for notification of the flight when there is no ATSU at the destination – see AIP ENR 1.10), including the phraseology to be used, should be contained in the aircraft operator's standard operating procedures and local operating procedures. These messages are not air traffic service messages and are not reproduced in this document.

#### 5.5.4 Helideck Movement

5.5.4.1 Helicopter crews must be provided with accurate information regarding the pitch, roll and heave of the helideck. Reports on pitch and roll should include values, in degrees, about both axes of the true vertical datum (i.e. relative to the true horizon) and be expressed in relation to the vessel's heading.

5.5.4.2 Pitch should be expressed in terms of 'up' and 'down' and roll should be expressed in terms of 'left' and 'right'. Heave should be reported in a single figure, being the total heave motion of the helideck rounded up to the nearest metre. Heave is taken to be

the vertical difference between the highest and lowest points of the helideck movement.

5.5.4.3 A standard radio message should be passed to the pilot containing the information on the helideck movement in an unambiguous format. Should the crew require other motion information or amplification of the standard message, they will request it.

| 5.5.4.4 An example of the 'standard message' would be: '(Pitch, roll and heave). Roll one degree left and three degrees right; pitch two degrees up and two degrees down; heave two metres'.

## 6 Radiotelephony Reports at Unattended Aerodromes

### 6.1 Introduction

- 6.1.1 Where an aeronautical communications frequency is allocated for use at a United Kingdom aerodrome, all RTF communications are to be conducted on the allocated frequency. For licensed aerodromes, allocated frequencies are promulgated in the UK AIP. A common frequency (135.475 MHz) known as 'SAFETYCOM' is made available for use at aerodromes where no other frequency is allocated (UK AIP GEN 3.4.5 refers) to enable pilots to broadcast their intentions to other aircraft that may be operating on, or in the vicinity of, the aerodrome.
- 6.1.2 At some UK aerodromes, air traffic movements may occur outside the promulgated hours of watch of Air Traffic Services (ATS). In order to improve the safety of these aerodrome operations, pilots should broadcast information on their intentions to other aircraft that may be operating on, or in the vicinity, of the aerodrome.
- 6.1.3 The phraseology to be used at an unattended aerodrome, as described in this section, is not to be used at aerodromes with ATS in attendance. Where ATS is provided, the relevant ATS unit will issue appropriate instructions.
- 6.1.4 All transmissions at unattended aerodromes shall be addressed to '(Aerodrome name) Traffic'. No reply to an unattended aerodrome report shall be transmitted.
- 6.1.5 Pilot reports are described for a Standard Overhead Join. This procedure will allow pilots to determine the runway in use and to orientate themselves with the circuit direction and other traffic. As specific joining and circuit procedures exist for some aerodromes, pilots should refer to the UKAIP to establish the procedure to be followed.
- 6.1.6 Unattended aerodrome reports are made at the discretion of the pilot. However, to ensure the traffic awareness of other pilots is correctly maintained, if a pilot elects to make reports, all those reports not listed as 'optional' should be included. Optional calls (illustrated in paragraph 6.3) may be included if additional traffic information is likely to assist traffic organisation or to enhance safety.
- 6.1.7 Monitoring of unattended aerodrome reports is not a substitute for visual observation and pilots must maintain traffic awareness and lookout even when making such calls, as not all aircraft may be monitoring radio broadcasts.
- 6.1.8 Transmission of unattended aerodrome reports does not confer any right-of-way. Pilots shall comply at all times with the Rules of the Air Regulations, in particular the rules for avoiding aerial collisions.


### 6.2 Additional Procedures for the Use of SAFETYCOM

- 6.2.1 SAFETYCOM is not an Air Traffic Service and no aeronautical ground station is associated with SAFETYCOM.
- 6.2.2 SAFETYCOM is a single common frequency and pilots should be aware of the possibility of congestion and breakthrough. It is particularly important when using SAFETYCOM that RTF transmissions identify the aerodrome name (suffixed 'traffic') in order to indicate the relevance of the report to other aircraft. Transmissions must be correct and concise.
- 6.2.3 SAFETYCOM transmissions shall only be made when aircraft are below 2000 ft above aerodrome level, or below 1000 ft above promulgated circuit height (if applicable) and within 10 nm of the aerodrome of intended landing

6.2.4 Where an aerodrome lies within controlled airspace, pilots are to call the appropriate ATSU and ensure that they obtain clearance to enter the airspace.


### 6.3 Unattended Aerodrome Phraseology Examples

#### 6.3.1 Taxiing Phraseology Example

 Borton Traffic, G-ABCD, TAXIING for Runway 09


*This transmission is optional and may be advisable at airfields where the view from an aircraft either in the air or on the ground may be restricted.*

#### 6.3.2 Departure Phraseology Example


 Borton Traffic, G-ABCD, LINING UP for departure Runway 09

#### 6.3.3 Joining the Circuit Phraseology Examples

 Borton Traffic, G-ABCD, 10 miles southwest JOINING OVERHEAD


 Borton Traffic, G-ABCD, Overhead joining for Runway 09 *(if determined)*


*This transmission is optional and may be advisable depending on other traffic in the vicinity*

 Borton Traffic, G-ABCD, Dead side descending Runway 09


*This transmission is optional and may be advisable depending on other traffic in the vicinity*

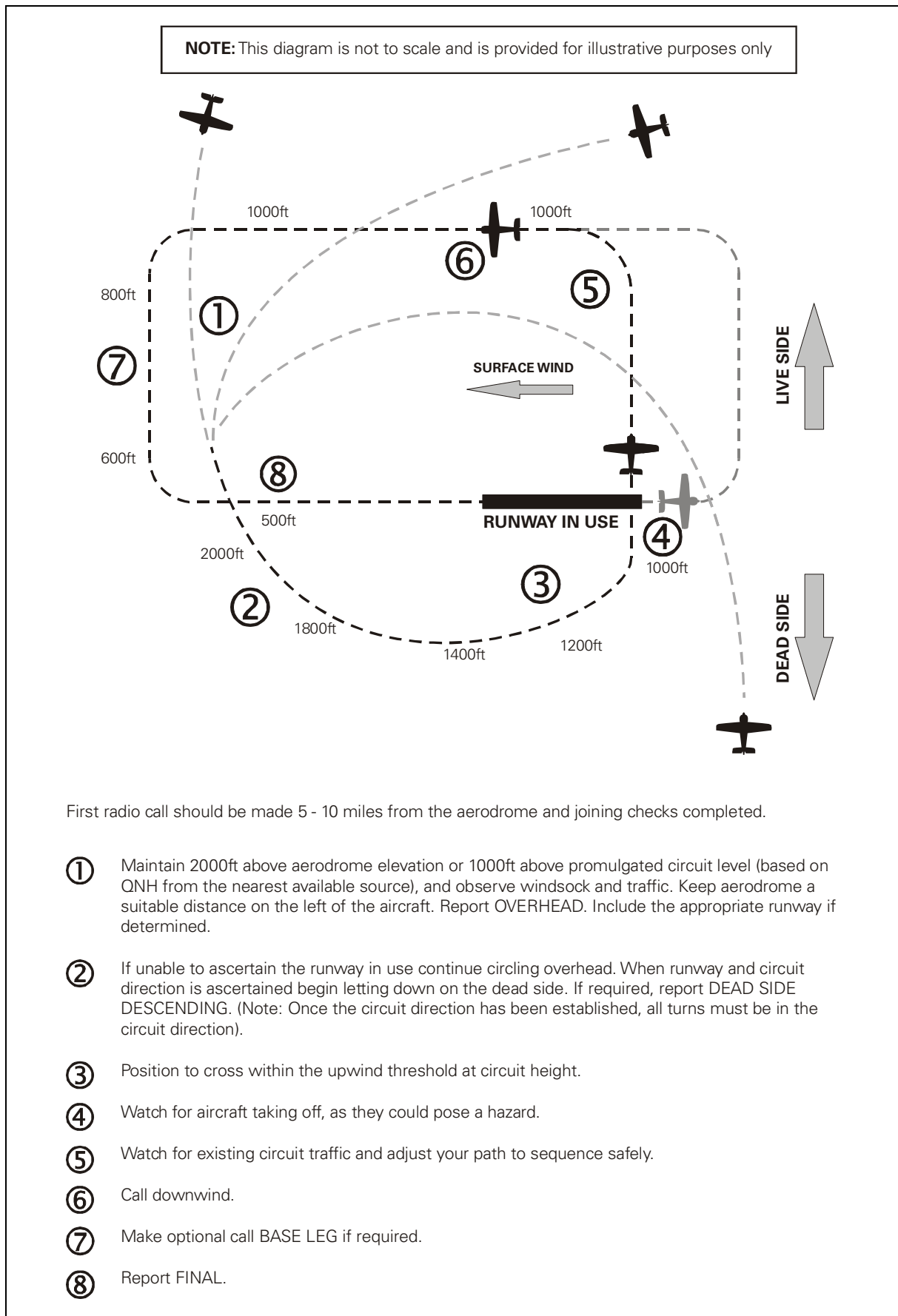
#### 6.3.4 Reporting in the Circuit Phraseology Examples

 Borton Traffic, G-ABCD, DOWNWIND *(Right-hand if applicable)* Runway 09 *(Intentions if applicable)*

 Borton Traffic, G-ABCD, BASE LEG Runway 09

*This transmission is optional and may be advisable depending on other traffic in the vicinity*

 Borton Traffic, G-ABCD, FINAL Runway 09





**Figure 2** Standard Overhead Join Procedure



## 7 Aerodrome Information

### 7.1 Meteorological Conditions

Meteorological information in the form of reports, forecasts or warnings is made available to pilots using the aeronautical mobile service either by broadcast (e.g. VOLMET) or by means of specific transmissions from ground personnel to pilots. Standard meteorological abbreviations and terms should be used and the information should be transmitted slowly and enunciated clearly in order that the recipient may record such data as is necessary.

	G-CD Borton Tower 0950 weather surface wind 360 degrees 5 knots visibility 30 kms. Nil weather, 2 oktas 2500 feet temperature plus 10, dew point plus 3, QNH 1010		QNH 1010 G-CD
---	---	---	---------------

**NOTE:** Cloud may also be reported as follows:

‘Scattered at five hundred feet, scattered cumulonimbus at one thousand feet, broken at two thousand five hundred feet.’

In the above example ‘scattered’ equates to 3 or 4 Octas and ‘broken’ equates to 5–7 Octas.

Full details of meteorological information is contained in UK AIP GEN section.

### 7.2 Voice Weather Broadcast (VOLMET) UK

7.2.1 Meteorological aerodrome reports for certain aerodromes are broadcast on specified frequencies. The callsign of the VOLMET, frequency, operating hours, aerodromes contained within the group, and contents are published in the UK AIP.

7.2.2 The content of a VOLMET broadcast is as follows:


- a) Aerodrome identification (e.g. Stourton)
- b) Surface wind
- c) Visibility (Note 1)
- d) RVR (if applicable) (Note 1)
- e) Weather
- f) Cloud (Note 1)
- g) Temperature
- h) Dewpoint
- i) QNH
- j) Trend (if applicable)


**NOTES:**


- 1 Non essential words such as ‘surface wind’, ‘visibility’ etc. are not spoken.
- 2 ‘SNOCLO’ is used to indicate that aerodrome is unusable for take-off/landings due to heavy snow on runways or snow clearance.
- 3 All broadcasts are in English.


### 7.3 Runway Visual Range (RVR)/Visibility/Absolute Minimum

- 7.3.1 When transmitting the runway visual range the abbreviation RVR will be used without using the phonetic word for each letter, e.g. RVR runway 27, 800 metres. The runway designator may be omitted if there is no possibility of confusion.
- 7.3.2 Where instrumented runway visual range (IRVR) observations are available, more than one reading may be transmitted.


 Fastair 345 RVR runway 27 650 600  
600

 Fastair 345

 Fastair 345 RVR runway 27  
touchdown 650 stop end 550

 Fastair 345

- 7.3.3 In the UK, there is an approach ban which states that a pilot may not continue an instrument approach beyond the outer marker, or equivalent position, if the reported RVR, or at aerodromes where RVR measurements are not taken or available, the visibility, is below the minimum specified for that approach. Essentially, this means that a pilot may not descend below 1,000 feet above the aerodrome when these conditions exist. This RVR/visibility is known as an 'absolute minimum'.
- 7.3.4 Should a pilot indicate that he or she intends to commence an instrument approach when the reported RVR/visibility is less than the notified 'absolute minimum' value, the controller should inform the pilot using the following RTF phraseology:

 Fastair 345 you are advised that the  
current RVR/visibility is (number)  
metres which is below the absolute  
minimum for a (name) approach to  
runway (number). What are your  
intentions?

### 7.4 Runway Surface Conditions

- 7.4.1 When conditions of standing water, with or without reports of braking action, are brought to the attention of ATS, the available information will be passed to aircraft likely to be affected.
- 7.4.2 When reports are based on inspections of the runway surface made by the aerodrome authority, the presence or otherwise of surface water on a runway will be assessed over the most significant portion of the runway (i.e., the area most likely to be used by aircraft taking off and landing).

**NOTE:** This area may differ slightly from one runway to another but will approximate to the central two-thirds of the width of the runway extending longitudinally from a point 100 m before the aiming point to 100 m beyond the aiming point for the reciprocal runway.

- 7.4.3 The presence or otherwise of surface water on a runway is reported in RTF and ATIS broadcasts using the following descriptions:


Reporting Term	Surface conditions
DRY	The surface is not affected by water, slush, snow, or ice. NOTE: Reports that the runway is dry are not normally to be passed to pilots. If no runway surface report is passed, pilots should assume the surface to be dry.
DAMP	The surface shows a change of colour due to moisture. NOTE: If there is sufficient moisture to produce a surface film or the surface appears reflective, the runway will be reported as WET.
WET	The surface is soaked but no significant patches of standing water are visible. NOTE: Standing water is considered to exist when water on the runway surface is deeper than 3mm. Patches of standing water covering more than 25% of the assessed area will be reported as WATER PATCHES.
WATER PATCHES	Significant patches of standing water are visible. NOTE: Water patches will be reported when more than 25% of the assessed area is covered by water more than 3mm deep.
FLOODED	Extensive patches of standing water are visible. NOTE: Flooded will be reported when more than 50% of the assessed area is covered by water more than 3mm deep.

- 7.4.4 Reports originated by the Aerodrome Authority are based on runway inspections and include the conditions in each third of the assessed area, sequentially, for the runway to be used.

 Fastair 345 Runway surface is DAMP, WATER PATCHES, WET


 Fastair 345 Runway surface is WET, WET, WET


- 7.4.5 Additional information, based on observations from the control tower or from pilot reports that indicate that the amount of water present on the runway surface is greater than that assessed, may be passed to pilots. Such additional information will be prefixed by the words "Unofficial observation". In this case, the runway surface conditions will be advised using a single term for the entire runway.

 Fastair 345 Unofficial observation based on pilot report. The runway surface condition appears to be WET

- 7.4.6 When suitable equipment is available reports of braking action on wet runways will be passed to pilots.

- 7.4.7 Other runway surface conditions, which may be of concern to a pilot, will be passed by ATS.

 Fastair 345 displaced threshold runway 27 500 feet due broken surface

 Fastair 345 braking action reported by B737 at 1456 poor

## 7.5 Automatic Terminal Information Service (ATIS) UK

- 7.5.1 To alleviate RTF loading at some busy airports, Automatic Terminal Information Service (ATIS) messages are broadcast to pass routine arrival/departure information on a discrete RTF frequency or on an appropriate VOR. Pilots inbound to these airports are normally required on first contact with the aerodrome ATSU to acknowledge receipt of current information by quoting the code letter of the broadcast. Pilots of outbound aircraft are not normally required to acknowledge receipt of departure ATIS except when requested on the actual ATIS broadcast. If, however, pilots report receipt of a departure ATIS broadcast the QNH should be included thereby allowing ATC to check that the quoted QNH is up-to-the-minute.
- 7.5.2 Aerodromes possessing ATIS, the hours of ATIS operation and the frequency employed are published in the UK AIP.
- 7.5.3 ATIS broadcasts which should be no more than thirty seconds duration, will include the following:
- Message identification i.e. 'This is Stourton Information Alpha'. Each message is consecutively coded using the phonetic alphabet.
  - Time of origin of weather report.
  - Weather report (see paragraph 2.2(a)–(c)).
  - Runway(s) in use.
  - Short term AIS information such as unserviceability of NAV AIDS, runway surfaces etc.
  - Any other routine information useful to pilots operating at the aerodrome.

### NOTES:

- RVR/RVRs are not included, however, IRVRs may be available where approved.
  - Rapidly changing meteorological situations sometimes make it impractical to include weather reports in the broadcast. In these circumstances, ATIS messages will indicate that weather information will be passed on RTF.
  - Any significant change to the content of a current ATIS message will be passed to pilots by RTF until such time as a new message is broadcast.
  - The highest cloud base that will be reported is 10000 feet.
- 7.5.4 Example of ATIS broadcast:

'This is Stourton Approach Information Alpha. 0850 hours weather. 240° 12 kts. 10 km. Intermittent slight rain. Scattered at 1000 ft, overcast at 1800 ft. Temperature +12. Dew point +7. QNH 1011 mbs. Landing runway 28. Report information Alpha received on first contact with Stourton.'

**NOTE:** A Trend may be included in an ATIS broadcast.

## Chapter 5 Radar Phraseology

### 1 General

#### 1.1 Introduction









1.1.1 This chapter contains general radar phraseology which is commonly used in communications between aircraft and all types of radar unit. Phraseology which is more applicable to approach radar control or area control is to be found in Chapters 6 and 7 as appropriate.

1.1.2 The phrase 'under radar control' shall only be used when a radar control service is being provided. Normally however, the callsign suffix used by the radar unit is sufficient to indicate its function.

1.1.3 In a radar environment heading information given by the pilot and heading instructions given by controllers are normally in degrees magnetic.

#### 1.2 Radar Identification of Aircraft

1.2.1 An aircraft must be identified before it can be provided with a radar service. However, the act of identifying aircraft is not a service in itself and pilots should **not** assume that they are receiving a radar service, particularly when they are flying outside controlled airspace.

 G-CD report heading	 G-CD heading 350
	 G-CD for identification turn left heading 320
	 Left heading 320 G-CD
	 G-CD identified 18 miles north-west of Borton, Radar Advisory
	 Radar Advisory G-CD
	or,
	 G-CD not identified. Resume own navigation
	 Wilco G-CD

1.2.2 When a controller has identified an aircraft he will inform the pilot, according to the circumstances, of the following:






- a) that the aircraft is identified, and
- b) of the position of the aircraft.

The occasions when the above information will be passed can be summarised as follows:

**Table 13**

Method of Identification	Aircraft flying inside controlled airspace		Aircraft flying outside controlled airspace	
	Inform Identified	Pass Position	Inform Identified	Pass Position
SSR	No	No	Yes	Yes
Turn	Yes	Yes	Yes	Yes
Departing aircraft	No	No	Yes	No
Position Report	No	No	Yes	No

- 1.2.3 The pilot will be warned if identification is lost, or about to be lost, and appropriate instructions given.

 G-CD radar service terminated due radar failure. Resume own navigation. Flight Information available from Wrayton on 125.75	 Changing to Wrayton 125.75 G-CD
 G-CD will shortly be leaving radar cover, radar service terminated. Flight Information available from Wrayton on 125.75	 G-CD changing to Wrayton 125.75
 G-CD	

### 1.3 Secondary Surveillance Radar Phraseology















- 1.3.1 The following phrases are instructions which may be given by controllers to pilots regarding the operation of SSR transponders. The phrases used by controllers are given together with their meanings; assignment of a code **does not** constitute the provision of a radar service.

**Table 14**

Phrase	Meaning
Squawk (code)	Set the code as instructed
Confirm squawk	Confirm the code set on the transponder
Reset squawk (code)	Reselect assigned code
Squawk Ident	Operate the special position identification feature
Squawk Mayday	Select Emergency
Squawk Standby	Select the standby feature
Squawk Charlie	Select altitude reporting feature
Check altimeter setting and confirm (level)	Check pressure setting and confirm your level
Stop squawk Charlie	Deselect altitude reporting
Stop squawk Charlie, wrong indication	Stop altitude report, incorrect level readout
* Confirm (level)	Check and confirm your level is 200 feet or less from that reported by the controller









\*Used to verify the accuracy of the Mode C derived level information displayed to the controller.

### 1.3.2 The pilot must respond to SSR instructions, reading back specific settings.

 Fastair 345 squawk 6411	 6411 Fastair 345
 Fastair 345 squawk ident	 Squawk ident, Fastair 345
 Fastair 345 squawk 6411 and ident	 6411 and ident, Fastair 345
 Fastair 345 confirm squawk	 6411 Fastair 345
 Fastair 345 reset squawk 6411	 Resetting 6411 Fastair 345
 Fastair 345 check altimeter setting	 1013 set Fastair 345
 Fastair 345 confirm transponder operating	 Fastair 345 negative, transponder unserviceable



## 1.4 Radar Service

Where it is not self-evident pilots will normally be informed by the controller when they are under radar control, advisory or information service.









 Fastair 345 under Radar Control	 Radar Control Fastair 345
 G-CD Radar Advisory	 Radar Advisory G-CD
 G-CD Radar Information	 Radar Information G-CD
 Fastair 345 radar service terminated	 Fastair 345

## 1.5 Radar Vectoring

1.5.1 Aircraft may be given specific vectors to fly in order to establish separation. Pilots may be informed of the reasons for radar vectoring.

 Fastair 345 delaying action. Turn left heading 050	 Left heading 050 Fastair 345
--	--

1.5.2 It may be necessary for a controller to know the heading of an aircraft as separation can often be established by instructing an aircraft to continue on its existing heading.


 Fastair 345 continue present heading	 Continue heading Fastair 345
 Fastair 345 report heading	 Fastair 345 heading 050
 Fastair 345 continue present heading and report that heading	 Continue heading 050 Fastair 345
 Fastair 345 continue heading 050	 Continue heading 050 Fastair 345

1.5.3 A controller may not know the aircraft's heading but does require the aircraft to fly a particular heading.


 G-CD fly heading 275	 Roger, turning left heading 275, G-CD
--	---




or,

 Roger, turning right 20 degrees heading 275, G-CD
---

- 1.5.4 When vectoring is complete, pilots will be instructed to resume their own navigation, given position information and appropriate instructions as necessary.


 Fastair 345 resume own navigation for Wicken, magnetic track 070 distance 27 miles
--


 Wilco Fastair 345
---


 G-CD resume own navigation for Walden position is 15 miles southeast of Westbury
--


 Wilco G-CD
--

- 1.5.5 Occasionally an aircraft may be instructed to make a complete turn (known as an orbit or a 360 degree turn), for delaying purposes or to achieve a required spacing behind preceding traffic.

 G-CD delaying action, orbit left for sequencing
--

 Orbit left G-CD
---

 Fastair 345 delaying action. Make a 360 turn left
---

 360 turn left Fastair 345
---

**NOTE:** 360 turn spoken as "TREE SIXTY TURN"

## 1.6 Traffic Information and Avoiding Action Phraseology





- 1.6.1 Whenever practicable, information regarding traffic on a possible conflicting path should be given in the following form:

- relative bearing of the conflicting traffic in terms of the 12 hour clock; or, if the aircraft under service is established in a turn, the relative position of the conflicting traffic in relation to cardinal points i.e. northwest, south etc.;
- distance from the conflicting traffic;
- direction of flight of the conflicting traffic; and
- relative speed of the conflicting traffic or the type of aircraft and level if this is known.

- 1.6.2 Relative movement should be described by using one of the following terms as applicable:

'closing, converging, parallel, same direction, opposite direction diverging, overtaking, crossing left to right, crossing right to left; (if level is known) – 1000 feet above/below.'

1.6.3 The controller will inform the pilot when the conflict no longer exists.

 G-CD unknown traffic 10 o'clock 6 miles crossing left to right height unknown fast moving. If not sighted turn left heading 270	 Left heading 270 G-CD
 G-CD clear of traffic resume own navigation direct Walden magnetic track 350 distance 13 miles	 Wilco G-CD





1.6.4 Avoiding action to be taken by the pilot is given when the controller considers that an imminent risk of collision will exist if action is not taken immediately

 G-CD avoiding action, turn left immediately heading 270 traffic at 10 o'clock 5 miles crossing left to right indicating slightly above fast moving	 Left heading 270 G-CD
--	---

## 1.7 ACAS/TCAS Phraseology



1.7.1 ACAS/TCAS equipment reacts to transponders of other aircraft in the vicinity to determine whether or not there is a potential conflict. The warning (Traffic Advisory (TA)), based on the time to an assumed collision enables the pilot to identify the conflicting traffic, and if necessary, take avoiding action (Resolution Advisory (RA)). In the UK, this equipment is mainly referred to as 'TCAS', however, the use of 'ACAS' is an acceptable alternative in phraseology terms.

1.7.2 Pilots should report TCAS manoeuvres.

 Fastair 345 TCAS climb/descent	 Fastair 345 Roger
 Fastair 345 TCAS clear of conflict, returning to (assigned clearance)	 Fastair 345 Roger

(Controllers may issue a revised clearance at this point.)

1.7.3 The pilot should report a TCAS manoeuvre even if it was not possible to notify the Controller that an RA had occurred.

 Fastair 345 TCAS climb/descent, clear of conflict, (assigned clearance) resumed	 Fastair 345 Roger
---	---

(Controllers may issue a revised clearance at this point.)


1.7.4 Pilots should report that they are unable to comply with a clearance as a result of a TCAS alert.

 Fastair 345 unable to comply, TCAS RA	 Fastair 345 Roger
---	---

In these circumstances the pilot should report when clear of the TCAS conflict.


## 1.8 Communications and Loss of Communications


When a controller suspects that an aircraft is able to receive but not transmit messages, the radar may be used to confirm that the pilot has received instructions. When further instructions are given they should be passed slowly, clearly and be repeated.

 G-CD reply not received if you read Wrayton turn left heading 040 I say again turn left heading 040

 G-CD turn observed I will continue to pass instructions

or,

 Fastair 345 reply not received if you read Wrayton squawk ident I say again squawk ident

 Fastair 345 squawk observed I will continue to pass instructions

### NOTES:

- 1 An aircraft experiencing a radio communications failure is expected to select the appropriate SSR code.
- 2 See also Chapter 8.

## 1.9 Danger Area Crossing Service/Danger Area Activity Information Service


1.9.1 In-flight information on the status of Danger Areas (DAs) is available from the nominated service units:


- a) Listed in the UK AIP.
- b) Detailed on the legend of the appropriate UK 1:500 000 Aeronautical Chart.

1.9.2 When available the DA service will either be a Danger Area Crossing Service (DACS) or a Danger Area Activity Information Service (DAAIS). If there is no reply from the appropriate nominated service unit which is to be called for these services, pilots are advised to assume that the relevant danger area is active.


### 1.9.3 Danger Area Crossing Service


The appropriate nominated service unit will, whenever the DA activity permits, provide a clearance for an aircraft to cross the danger area under a RIS or FIS. The clearance is only in relation to Danger Area activity and does not, in traffic management terms, constitute separation from aircraft which might be operating in the area.


 Westbury Approach, G-ABCD request Danger Area Crossing Service of Loudwater Range

 G-ABCD Westbury Approach Flight Information Service. Loudwater active. Report 10 miles from Loudwater

 Wilco G-ABCD


 Westbury Approach G-ABCD 10 miles from Loudwater


 G-CD Loudwater remains active.  
Suggest you re-route


 Re-routing to the east of Loudwater and changing to Wrayton  
Information 125.75 G-ABCD


 G-ABCD


or,

 G-ABCD Westbury Approach.  
Loudwater not active, range crossing approved report vacating the range

 Range crossing approved. Wilco G-ABCD

 G-ABCD vacating Loudwater Range


 G-CD Westbury Approach roger, Flight Information available from Wrayton on 125.75


 Changing to Wrayton on 125.75 G-CD

#### 1.9.4 Danger Area Activity Information Service

The nominated service unit will pass to the pilot, on request, an update on the known activity status of the danger area. Such an update will assist the pilot to decide whether it would be prudent, on flight safety grounds, to penetrate the Danger Area. A DAAIS does NOT constitute a clearance to cross a Danger Area.

 Westbury Approach G-ABCD request DAAIS for Loudwater Range

 G-ABCD Westbury Approach Loudwater Active/Not Active

 Loudwater Active/Not Active G-ABCD







#### 1.9.5 Full details of DACS/DAAIS can be found in the UK AIP and AICs.

## Chapter 6 Approach Phraseology

### 1 Approach Control Service Phraseology


#### 1.1 IFR Departures

- 1.1.1 At many airports both arrivals and departures are handled by a single approach control unit. At busier airports departures and arrivals may be handled separately.
- 1.1.2 Pilots of all aircraft flying Instrument Departures are to include the following information on first contact with approach control/departure radar:
- Call sign;
  - SID Designator where appropriate;
  - Current or passing ALT/FL; **PLUS**
  - Cleared ALT/FL. For Standard Instrument Departures involving stepped climb profiles, state the initial ALT/FL to which the aircraft is climbing.
- 1.1.3 In addition to the ATC route clearance, departing IFR flights may be given additional instructions to provide separation in the immediate vicinity.


 Fastair 345 Stourton Approach continue heading 040 until passing FL 70 then route direct Wicken	 Heading 040 until passing FL 70 then direct Wicken Fastair 345
 Fastair 345 report passing FL 70	
 Fastair 345 passing FL 70 routing direct Wicken	
 Fastair 345 contact Wrayton Control 129.1	
 Wrayton Control 129.1 Fastair 345	


#### 1.2 VFR Departures


- 1.2.1 Departing VFR flights, when handled by approach control, may be passed information on relevant known traffic in order to assist the pilot in maintaining his own separation. Pilots should report leaving the area of jurisdiction of the approach control units.

 Borton Approach G-CD passing the zone boundary	 G-CD Flight Information available from Wrayton 125.75
 Wrayton Information 125.75 G-CD	

- 1.2.2 Special VFR flights will be given specific instructions in the clearance to leave the control zone.


 G-CD cleared to the zone boundary route via Whiskey Special VFR not above altitude 1500 feet


 Cleared to the zone boundary, route via Whiskey Special VFR not above altitude 1500 feet G-CD


 G-CD correct

### 1.3 IFR Arrivals


- 1.3.1 Aircraft flying within controlled airspace will normally receive descent clearance to the clearance limit from the ACC prior to transfer to an approach control unit. On transfer to approach control further descent instructions may be given.


 Kennington Approach Fastair 345 descending FL 90 Information Charlie


 Fastair 345 Kennington Approach cleared direct to North Cross descend FL 50


 Direct to North Cross descend FL 50 Fastair 345


- 1.3.2 Arriving IFR flights operating outside controlled airspace are not permitted to enter controlled airspace until cleared to do so. Clearances will be given in a way similar to that in paragraph 3.1 above. In the examples below the initial approach fix is Kennington NDB (or VOR), callsign KTN.


 Kennington Approach Fastair 345


 Fastair 345 Kennington Approach pass your message


















 Fastair 345 from Stourton 25 miles southeast Kennington IFR, FL 125 estimating zone boundary 20 KTN 24 information Charlie

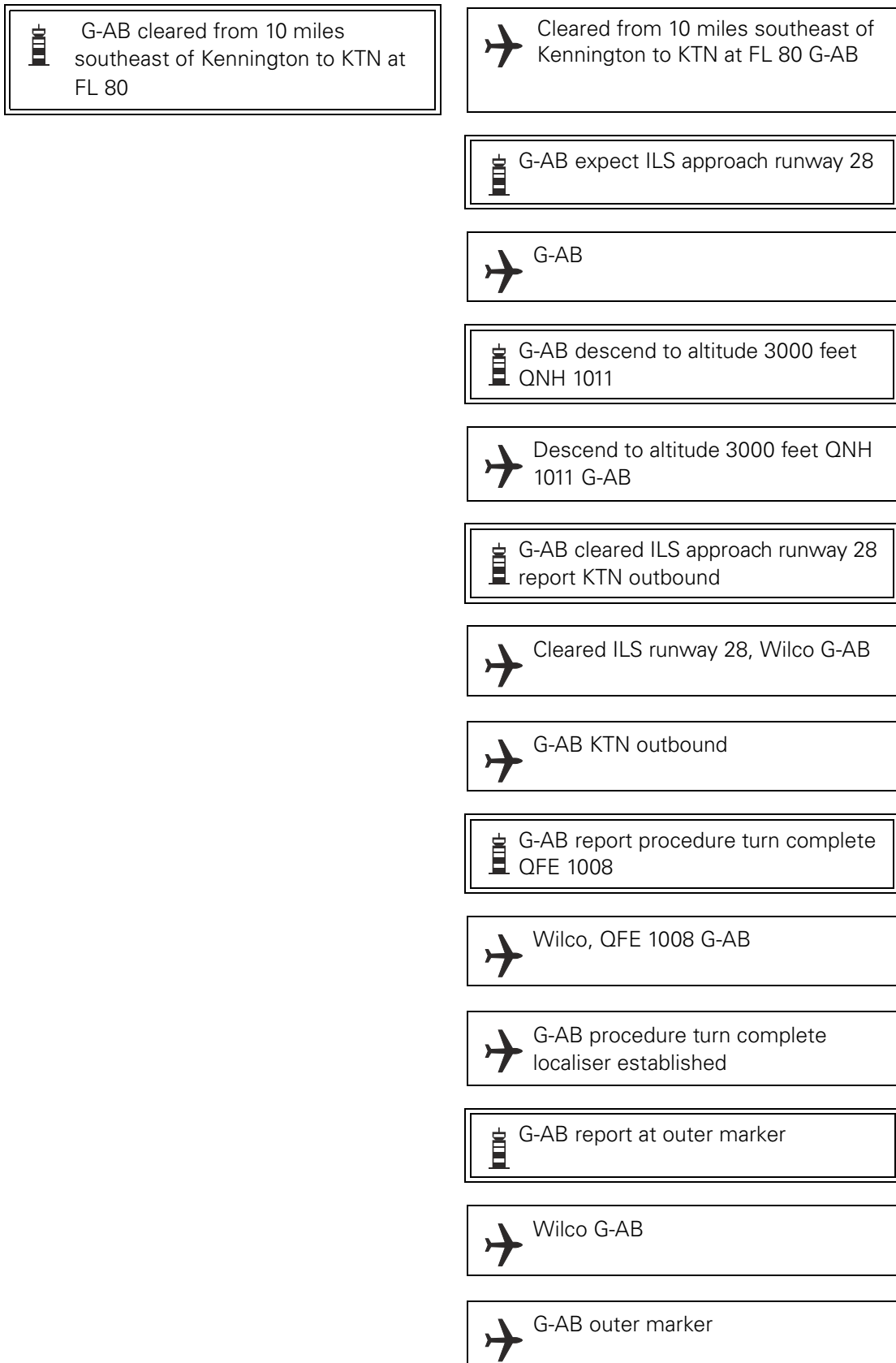
 Fastair 345 cleared from 10 miles southeast of Kennington to KTN at FL 60. Enter controlled airspace at FL 85 or below

 Cleared from 10 miles southeast of Kennington to KTN at FL 60. Enter controlled airspace southeast of Kennington at FL 85 or below Fastair 345

 Fastair 345 expect ILS approach runway 28 QNH 1011

 ILS runway 28 QNH 1011 Request straight in approach Fastair 345

	 Fastair 345 cleared straight in ILS approach runway 28, descend to altitude 3000 feet QNH 1011, report established on the localiser
	 Cleared straight in ILS approach runway 28 descend to altitude 3000 feet QNH 1011, Wilco Fastair 345
	 Fastair 345 established on the localiser
	 Fastair 345 QFE 1008
	 QFE 1008 Fastair 345 runway in sight
	 Fastair 345 number 1 contact Tower 118.7
	 Number 1 Tower 118.7 Fastair 345
 Kennington Tower Fastair 345	 Fastair 345 Kennington Tower report outer marker
	 Fastair 345
 Fastair 345 outer marker	 Fastair 345 runway 28 cleared to land surface wind 280 8
	 Runway 28 cleared to land Fastair 345
 Kennington Approach G-DCAB	 G-DCAB Kennington Approach pass your message
	 G-DCAB PA 31 inbound from Stourton IFR FL 80 estimate KTN 47 information Delta
	 G-AB remain outside controlled airspace. Time is 41. Expect joining clearance at 44







G-AB contact Tower 118.9



Tower 118.9 G-AB

**NOTE:** Pilots may be requested to change to tower frequency at any point on final approach.

- 1.3.3 On occasions IFR aircraft do not complete the instrument approach procedure but request permission to make a visual approach.



G-AB over KTN 3000 feet field in sight, request visual approach

G-AB cleared visual approach  
runway 28 QFE 1008Cleared visual approach runway 28  
QFE 1008 G-AB

- 1.3.4 Normally a holding procedure is published. However, the pilot may require a detailed description of a specific holding procedure.

Fastair 345 hold at North Cross FL  
60 expect onward clearance at  
time 40Hold at North Cross FL 60, request  
holding procedure Fastair 345Fastair 345 hold at North Cross FL 60  
inbound track 265 degrees turns left  
outbound time 1 minute

It should be noted that the above information is passed in the following order and is for holds **other** than VOR/DME:











- a) Fix
- b) Level
- c) Inbound track
- d) Right or left turns
- e) Time of leg

- 1.3.5 Holding information for VOR/DME substitutes DISTANCE for TIME in e) above:

Fastair 345 request holding  
procedureFastair 345 hold on the Marlow  
VOR/DME at 20 DME FL 100  
inbound track 265 degrees turns left,  
limiting outbound distance 24 DME

## 1.4 VFR Arrivals

- 1.4.1 Depending on the procedures in use, the pilot of an arriving VFR flight may be required to establish contact with the approach control unit and request instructions before entering its area of jurisdiction e.g. before entering a control zone. Where there is an ATIS broadcast the pilot should acknowledge that he has received it; where no ATIS broadcast is provided the approach controller will pass the aerodrome data.

 Kennington Approach G-DCDN	 G-DCDN Kennington Approach pass your message
	 G-DCDN C172 inbound from Stourton VFR 2500 feet Wessex 1011 estimating zone boundary 52 Kennington 02 information golf
	 G-DN cleared from the zone boundary to Kennington VFR, at 2500 feet Kennington QNH 1012. Traffic is a southbound Cherokee 2000 feet VFR estimating zone boundary 53
	 Cleared from the zone boundary to Kennington VFR at 2500 feet QNH 1012, traffic in sight G-DN
	 G-DN report aerodrome in sight
	 Wilco G-DN
	 G-DN aerodrome in sight
	 G-DN contact Tower 118.5
	 Tower 118.5 G-DN

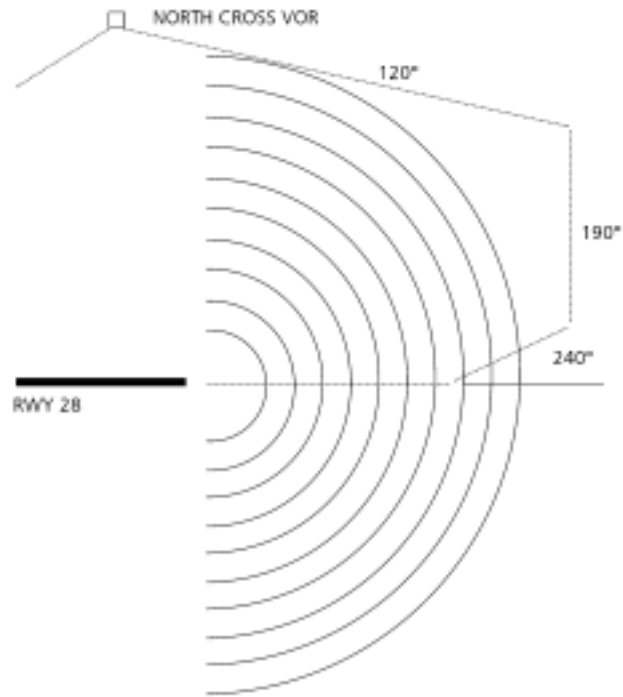
**NOTE:** The phraseology for joining the aerodrome traffic circuit is detailed in Chapter 4, paragraph 1.8.

## 1.5 **Special VFR Flights**











- 1.5.1 Special VFR clearances are only issued for flights within Control Zones and are normally at the request of the pilot. The pilot –
- a) must comply with ATC instructions;
  - b) is responsible for ensuring that his flight conditions enable him to remain clear of cloud, determine his flight path with reference to the surface and to keep clear of obstructions;
  - c) is responsible for ensuring that he flies within the limitations of his licence;
  - d) is responsible for complying with the relevant low flying restrictions of Rule 5 of the Rules of the Air Regulations. Note: Whilst the 1500 ft rule may not apply to a pilot in receipt of a Special VFR clearance, the 'alight clear' rule always applies. The responsibility to determine whether to accept a Special VFR clearance and still comply with this rule rests with the pilot.
  - e) is responsible for avoiding aerodrome traffic zones unless prior permission for penetration has been obtained from the relevant ATSU.
- 1.5.2 A full flight plan is not required for Special VFR flight but the pilot must give brief details of the callsign, aircraft type and pilot's intentions, including ETA at entry point. A full flight plan is required if the pilot wishes his destination to be notified.
- 1.5.3 Aircraft are not normally given a specific height to fly but vertical separation from aircraft flying above can be achieved by requiring the Special VFR flight to fly not above a specified level (paragraph d) above must be borne in mind by pilots).
- 1.5.4 No separation will be provided between Special VFR flights which are flying in notified areas or routes where an individual clearance is not required, or between flights using such areas or routes and other flights on Special VFR clearances. Full details of the procedures for Special VFR flights appear in the UK AIP, ENR, Section 1.


## 1.6 **Vectoring to Final Approach**


- 1.6.1 Radar vectors are given to arriving flights to position them onto a pilot interpreted approach aid, to a point from which a radar-assisted approach can be made or to a point from which a visual approach is made.
- 1.6.2 MLS equipment will provide an "ILS look-a-like" straight in approach and the terms "Localiser" and "Glidepath" are retained. Due to the possibility of confusion between the words "ILS" and "MLS", an MLS approach is referred to as a "Microwave Approach" in RTF communication.
- 1.6.3 In the following example an identified aircraft inbound to Kennington is given radar vectors to the ILS. Where applicable "Microwave" is shown (in brackets) to indicate appropriate MLS phraseology (see Figure 3.)





**Figure 3 Radar vectors to an ILS approach**


 Kennington Approach Fastair 345 FL 60 information golf	 Fastair 345 Kennington Approach vectoring for ILS (or Microwave) approach runway 28
 Fastair 345 leave North Cross heading 120	 Fastair 345
 Fastair 345 report speed	 Leave North Cross heading 120 Fastair 345
	 Fastair 345 speed 260 knots
	 Fastair 345 reduce speed to 210 knots
	 210 knots Fastair 345
	 Fastair 345 leaving North Cross heading 120


 Fastair 345 Roger descend to altitude 2500 feet QNH 1011 number 4 in traffic


 Descend to altitude 2500 feet QNH 1011 Fastair 345


 Fastair 345 position 10 miles northeast of Kennington. This is a right hand circuit for runway 28.


 Fastair 345


 Fastair 345 turn right heading 190 base leg, no ATC speed restrictions


 Right heading 190. No speed restriction Fastair 345


 Fastair 345 12 miles from touchdown turn right heading 240 closing localiser from the right report established


 Right heading 240 ILS (or Microwave) Wilco Fastair 345

 Fastair 345 localiser established





 Fastair 345 descend on the ILS (or Microwave) QFE 1008

 Wilco, QFE 1008 Fastair 345

 Fastair 345 contact Tower 118.5

 Tower 118.5 Fastair 345

1.6.4 In the example above the approach speed of the aircraft is reduced to maintain separation between aircraft in an approach sequence. Where speed adjustment would be insufficient, it may be necessary to issue additional vectors.

 Fastair 345 make a 360 turn left for delaying action	 360 turn left Fastair 345
 Fastair turn left heading 220 for spacing	 Left heading 220 Fastair 345

**NOTE:** 360 spoken as “TREE SIXTY”

## 1.7 Direction Finding (DF)







1.7.1 The aeronautical stations that offer a VHF Direction Finding (VDF) service are listed in the UK AIP AD. Some VDF stations stipulate that the service is not available for en-route navigation purposes (except in emergency). VDF bearing information will only be given when conditions are satisfactory and radio bearings fall within calibrated limits of the station. If the provision of a radio bearing is not possible the pilot will be told of the reason.

A pilot may request a bearing or heading using the appropriate phrase or Q code to specify the service required. Each aircraft transmission shall be ended by the aircraft call sign. A VDF station will provide the following as requested:

- QDR – Magnetic bearing of the aircraft from the station (i.e. .... Approach G-ABCD request QDR G-ABCD).
- QDM – Magnetic heading to be steered by the aircraft (assuming no wind) to reach the VDF station (i.e. .... Approach G-ABCD request QDM G-ABCD).
- QTE – True bearing of the aircraft from the station (i.e. .... True bearing, True bearing ..... Approach G-ABCD request True bearing (or QTE) G-ABCD).

The direction-finding station will reply in the following manner:

- The appropriate phrase or Q code.
- The bearing or heading in degrees in relation to the direction finding station.
- The class of bearing.
- The time of observation, if necessary.

 Kennington Approach G-ABCD request QDM G-ABCD	 G-ABCD Kennington Approach QDM 090 degrees class Bravo
	 QDM 090 degrees class Bravo G-ABCD
 True bearing, true bearing, Kennington Approach G-ABCD request true bearing G-ABCD	 G-ABCD Kennington Approach true bearing 276 degrees true, I say again, 276 degrees true class bravo
	 True bearing 276 degrees class Bravo G-ABCD

1.7.2 The accuracy of the observation is classified as follows:

Class A – Accurate within plus or minus 2 degrees

Class B – Accurate within plus or minus 5 degrees

Class C – Accurate within plus or minus 10 degrees

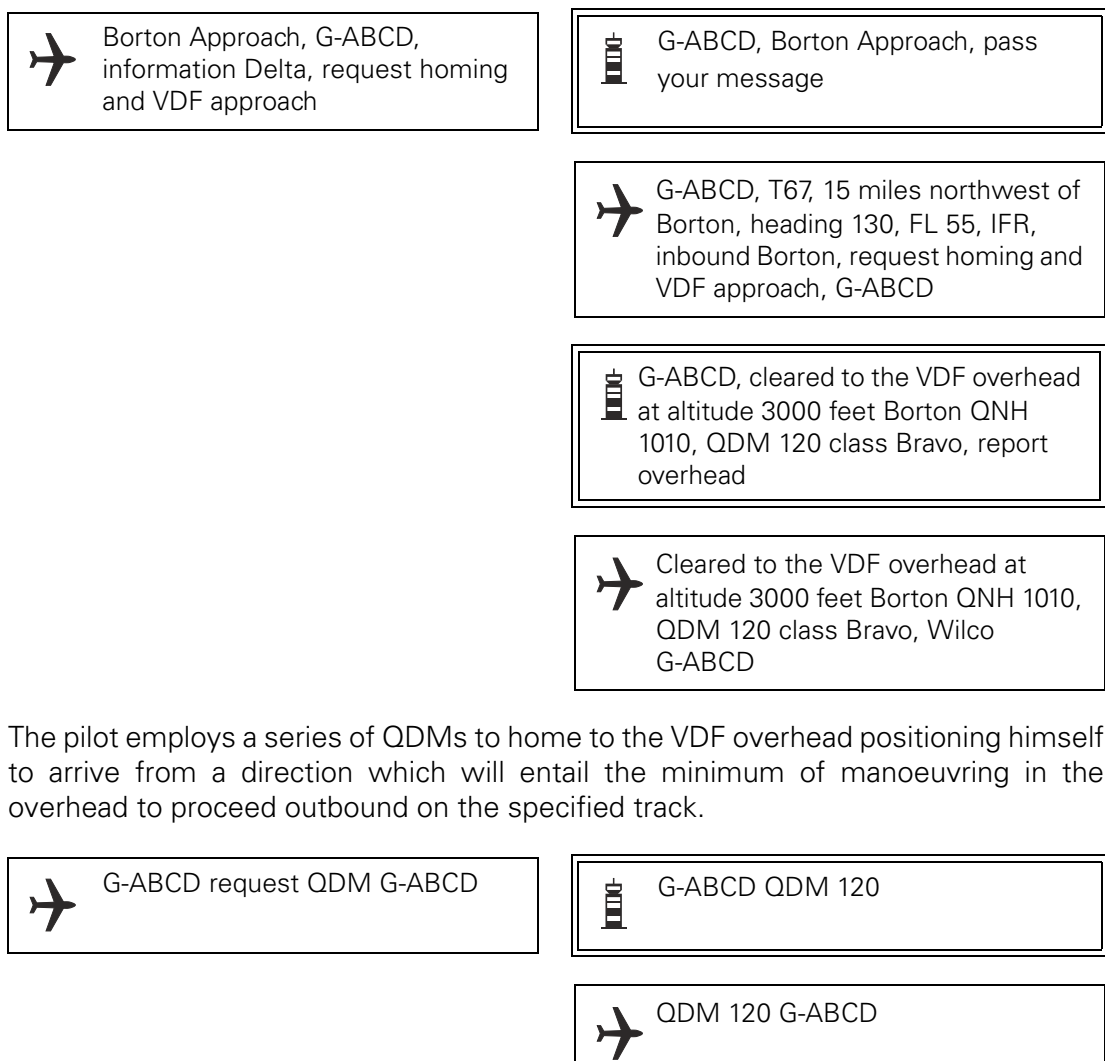
Class D – Accuracy less than Class C

**NOTE:** Normally no better than Class B bearing will be available.


## 1.8 VDF Procedure


1.8.1 This is a procedure whereby a pilot requests a series of QDMs to home to a VDF station on or near an aerodrome and to carry out a prescribed VDF instrument approach procedure to the aerodrome. VDF procedures are notified in the AD section of the UK AIP.


1.8.2 Requests for QDMs are normally initiated by the pilot at intervals of about 1 minute during the initial stages of the homing, increasing in frequency as the VDF overhead is approached. During this procedure QDMs are requested as required to achieve and maintain the specified tracks. **The VDF Procedure is totally pilot interpreted.**





 G-ABCD maintaining 3000 feet,  
request QDM G-ABCD


 G-ABCD Roger, QDM 130

 QDM 130 G-ABCD


 G-ABCD request QDM, G-ABCD


 G-ABCD QDM 145, cleared VDF  
approach runway 34


 QDM 145, cleared VDF approach  
runway 34 G-ABCD


 G-ABCD request QDM G-ABCD


 G-ABCD QDM 150


 QDM 150 G-ABCD

 G-ABCD request QDM G-ABCD


 G-ABCD no bearing

 G-ABCD request QDM G-ABCD

 G-ABCD no bearing

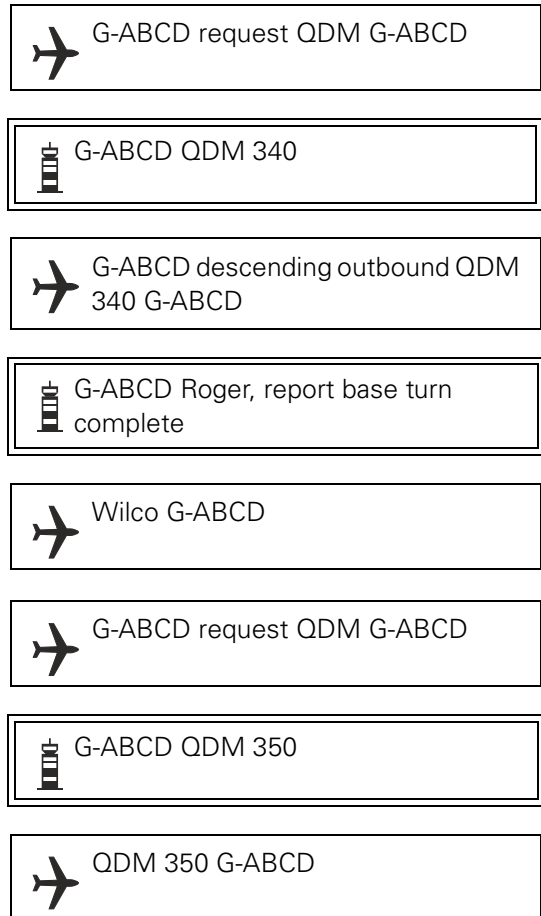
 G-ABCD overhead turning outbound

 G-ABCD report descending in the  
procedure QFE 1007

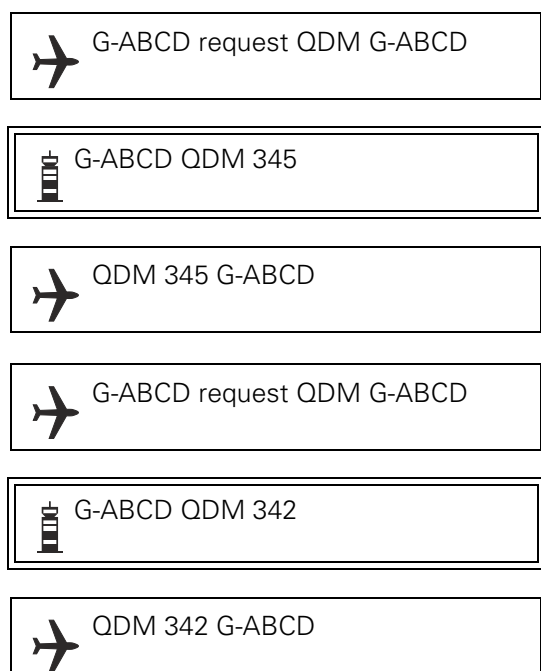
 Wilco, QFE 1007 G-ABCD





- 1.8.4 The pilot starts timing the outbound leg and, employing a series of QDMs to establish and maintain the prescribed track, descends as notified for the procedure. The timed outbound leg ends with a turn (normally level) onto the final approach QDM.




- 1.8.5 At the end of the outbound leg the pilot turns as prescribed onto the final approach QDM using a series of QDMs during the turn to achieve the final QDM.





 G-ABCD base turn complete,  
descending inbound, G-ABCD


 G-ABCD continue approach, report  
visual QFE 1007


 G-ABCD Wilco, QFE 1007, request  
QDM G-ABCD


 G-ABCD QDM 338


 QDM 338 G-ABCD


 G-ABCD request QDM G-ABCD

 G-ABCD QDM 340


 QDM 340 G-ABCD


 G-ABCD visual


 G-ABCD contact Tower 118.7

 Tower 118.7 G-ABCD

1.8.6 If no visual contact is gained, a missed approach is initiated at the missed approach point which is normally the VDF overhead.










 G-ABCD request QDM G-ABCD

 G-ABCD no bearing

 G-ABCD nothing seen, going around


## 1.9 NDB(L) and VOR Procedures


1.9.1 NDB(L) and VOR instrument approach procedures are pilot interpreted procedures notified for particular aerodromes and runways where procedural tracks are defined by NDB(L) bearings or VOR radials. Some NDB(L) and VOR procedures may include marker beacons or DME to provide ranging information. Aircraft may also be radar vectored to an NDB(L) or VOR final approach track. An example of a typical NDB(L) instrument approach procedure to an aerodrome outside controlled airspace follows; similar RTF phraseology may be employed in VOR procedures.


 Borton Approach, G-ABCD inbound Borton, information Delta	 G-ABCD, Borton Approach pass your message
	 G-ABCD, T67, 20 miles South of Borton, FL 80, IFR, estimating BTN 47, request beacon approach
	 G-ABCD cleared to BTN at FL 80, expect beacon approach RW 34, expected approach time 58
	 Cleared to BTN FL 80 to hold. Expected approach time 58. G- ABCD
	 G-CD descend to altitude 3000 feet, Borton QNH 1015, report entering the hold
	 Descend to altitude 3000 feet Borton QNH 1015, wilco, G-CD
	 G-CD overhead the BTN, maintaining 3000 ft entering the hold
	 G-CD

### NOTES:


- 1 All manoeuvres associated with entering the holding pattern are considered to be part of the holding procedure.
- 2 Aircraft engaged in holding for training purposes should notify the controller on the commencement of the penultimate hold, e.g. 'G-CD on completion of this hold, request commence procedure'.


 G-CD cleared beacon approach runway 34, report beacon outbound
---


 Cleared for beacon approach runway  
34, Wilco, G-CD


 G-CD beacon outbound

**NOTE:** Beacon outbound should be called only at the final passage over the beacon when commencing the outbound portion of the procedure.


 G-CD report base turn complete, QFE  
1013


 Wilco, QFE 1013 G-CD


 G-CD base turn complete

 G-CD report at 4 DME

 Wilco, G-CD


 G-CD 4 DME


 G-CD Roger, contact Tower 118.7

 Tower 118.7, G-CD

## 1.10 Surveillance Radar Approach (SRA)



















1.10.1 During a surveillance radar approach (SRA) the pilot is given distances from touchdown, advisory height information and azimuth instructions to enable him to make an approach to a particular runway. Controllers at civil aerodromes in the UK will normally pass advisory heights based on the QFE.


 Fastair 345 this will be a surveillance radar approach terminating at half a mile from touchdown. Check your minima, step down fixes and missed approach point


 Fastair 345


**NOTE:** Where step down fixes do not exist in local SRAs, approval for a modified RTF procedure may be sought from ATSSD.

- 1.10.2 If a pilot wishes to conduct his approach by reference to altitude he must inform the controller and request the QNH. The controller, when passing the QNH, will add the aerodrome or touchdown elevation to the advisory heights. All references to the level of the aircraft will then be to altitude.
- 1.10.3 If the pilot reports visual in the early stages of the approach he will be asked whether he wishes to continue the SRA. Normally aircraft will not be transferred to aerodrome control until after they have completed the SRA approach and have landed.
- 1.10.4 The range at which the descent begins depends on the height of the aircraft during the intermediate phase and the angle of the glide path. The following example commences when the aircraft, having been descended to 2000 feet QFE, is awaiting instructions for an approach on a three degree glide path.


 Fastair 345 turn right heading 275 final approach	 Right heading 275 Fastair 345
 Fastair 345, 8 miles from touchdown. Your descent will begin at 6½ miles. Check wheels	 Fastair 345
 Fastair 345, 7 miles from touchdown. Report runway lights in sight	 Fastair 345
 Fastair 345 after landing contact Kennington tower on 118.5	 After landing Kennington tower 118.5 Fastair 345
 Fastair 345 approaching 6½ miles from touchdown. Commence descent now to maintain a three degree glide path	 Descending Fastair 345
 6 miles from touchdown. Height should be 1850 feet	 Fastair 345
 Slightly left of track. Turn right heading 280	 Heading 280 Fastair 345
 5½ miles from touchdown. Height should be 1700 feet	 Fastair 345
 5 miles from touchdown. Height should be 1550 feet. Heading 280 is good	 Fastair 345


 4½ miles from touchdown. Height should be 1400 feet. Slightly right of track. Turn left 3 degrees heading 277


 Heading 277, Fastair 345


 4 miles from touchdown. Height should be 1250 feet. Do not reply to further instructions


(the gap between further transmissions will be less than 5 seconds)

 3½ miles from touchdown. Height should be 1100 feet. Runway 28 cleared to land. Surface wind calm


 3 miles from touchdown. Height should be 950 feet. Heading 277 is good

 2 ½ miles from touchdown. Height should be 800 feet. On track

 2 miles from touchdown. Height should be 650 feet. Check minimum descent height

 1 ½ miles from touchdown. Height should be 500 feet. On track

 1 mile from touchdown. Height should be 350 feet

 On track. Half a mile from touchdown. Approach completed. Out

1.10.5 When the SRA terminates at 2 miles from touchdown the advisory level checks at half mile intervals are omitted and pilots are expected to reply to all transmissions from the ground station.

1.10.6 Height checks below the category A aircraft OCH will be omitted.

### 1.11 **Landing Altimeter Setting (QNE)**

QNE is the indication which the altimeter will give on landing, at a particular time and place, when the millibar scale is set to 1013.2 mb. QNE information may be used by pilots of aircraft whose altimeters cannot be set to below 950 mb. The QFE/QNE conversion will be calculated by ATC.

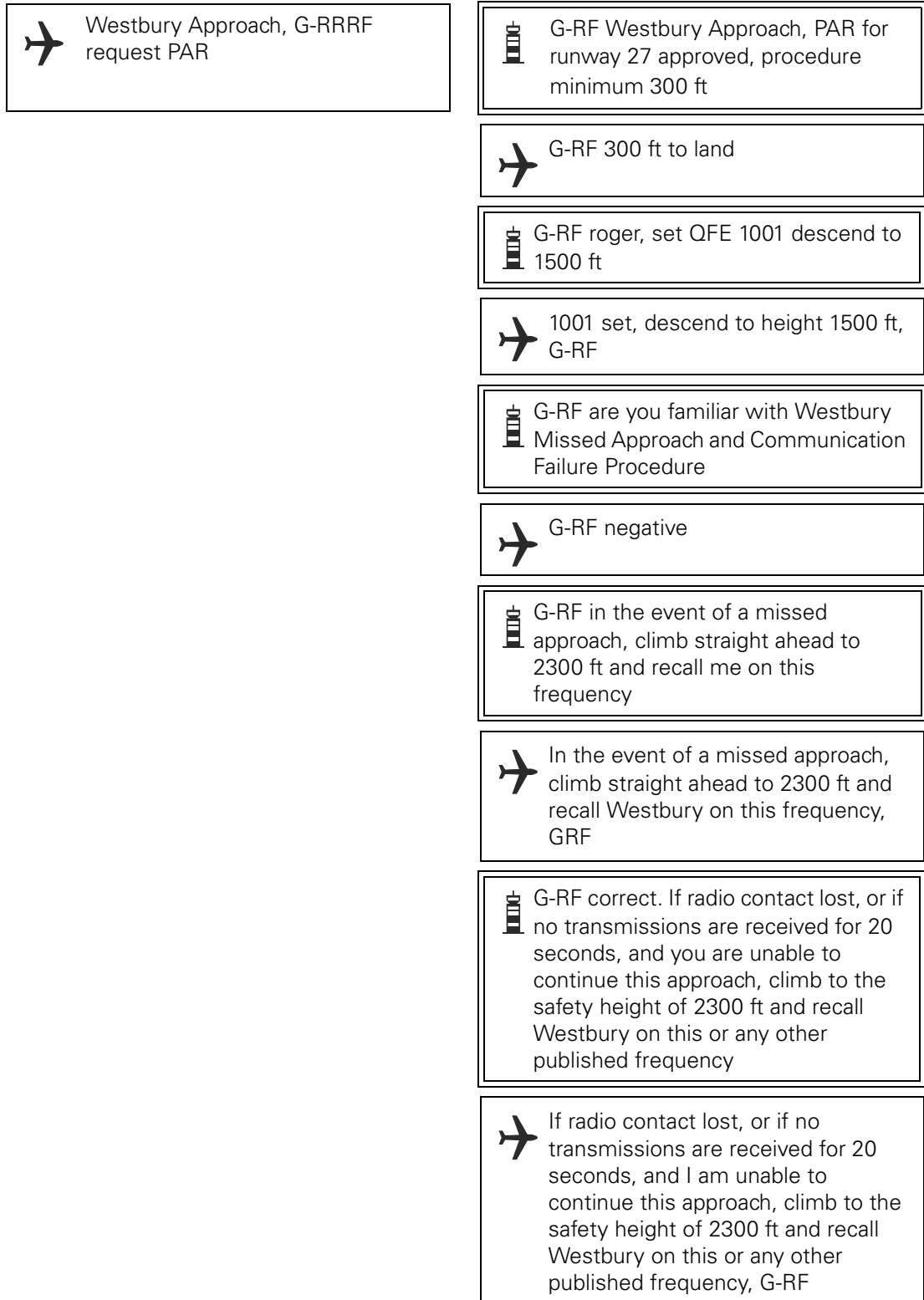
Example: QFE 947.6























Set 1013.2 on altimeter

Altimeter will read 1842 ft on touchdown

## 1.12 PAR Approach

1.12.1 Pilots visiting military airfields may wish to undertake a PAR Approach (Precision Approach Radar). The following scenario assumes that G-RRRF has already been identified by Westbury Approach and is under an ATC service at 2500 ft on the Regional Pressure Setting.



	 G-RF correct. Turn right heading 100 downwind
	 Right heading 100 G-RF
	 G-RF heading 100, maintaining 1500 ft
 G-RF, 5 miles downwind, cockpit checks report complete	 G-RF cockpit checks complete
 G-RF turn left heading 360 base leg	 Left heading 360, G-RF
 G-RF heading 360	 G-RF turn left heading 310
	 Left heading 310, G-RF
 G-RF heading 310	 G-RF turn left heading 265 final approach
	 Left heading 265, G-RF
	 G-RF, 8 miles, contact Westbury Talkdown on 123.3
	 Westbury Talkdown 123.3 G-RF
 Westbury Talkdown G-RRRF	 G-RF Westbury Talkdown identified, turn right heading 270, readback QFE
	 Right heading 270, QFE 1001 set G-RF
 G-RF 7 miles, correcting nicely to the centreline	 G-RF
 G-RF 6½ miles, slightly right of centreline, turn left heading 265	 Left heading 265, G-RF





G-RF when safely on the runway  
contact Westbury Tower on 132.85



When safely on the runway contact  
Westbury Tower on 132.85, G-RF



G-RF 6 miles, correcting nicely to the  
centreline, approaching descent point  
do not acknowledge further  
instructions unless requested



5½ miles, heading is good



Turn right 3° heading 268



5 miles begin descent now for a 3°  
glidepath, on the centreline



Turn right 2° heading 270, on the  
centreline, slightly above the glidepath



4½ miles heading is good, correcting  
to the glidepath



On glidepath, on centreline, heading  
270



4 miles, slightly below glidepath,  
check gear acknowledge



Gear down, G-RF




Slightly left of centreline turn right  
heading 273, correcting nicely to the  
glidepath





3½ miles on glidepath, slightly left of  
centreline





Turn left 3° heading 270 on centreline


 3 miles, cleared to land, surface wind 250 5, on glidepath, on centreline heading 270


 Turn left 2° heading 268, on centreline, on glidepath


 2½ miles, on centreline, on glidepath


 2 miles, slightly right of centreline, turn left 3° heading 265, on glidepath


 Slightly above glidepath, correcting nicely to the centreline, heading 265


 1½ miles, heading is good, correcting to the glidepath


 Approaching decision height, on glidepath, on centreline, turn right 3° heading 268

 1 mile, on glidepath, on centreline

 Slightly above glidepath, on centreline

 ½ mile, on glidepath on centreline

 G-RF over touchdown

 G-RF changing to Westbury Tower 132.85

 G-RF

1.12.2 The following phrases may also be encountered during a PAR; further explanation of some of the terms employed are included in the Remarks column in the table below:

**Table 15**

Position	Control to Aircraft	Aircraft to Control	Remarks
Initial approach	G-RF Westbury, PAR Azimuth only for runway 27 approved, procedure minimum .... ft	.... ft, G-RF	Employed when no glidepath information is available
Glidepath and rate of descent	Well above/below glidepath. Acknowledge G-RF  correcting rapidly to glidepath	G-RF	
Range	.... miles		Passed at ½ nm intervals. (RN pass ranges at 1/3 nm intervals)
Heading	Well/slightly left/ right of centreline  correcting rapidly/ slowly/nicely to centreline		
Glidepath failure during PAR	Glidepath failure, the procedure minimum is .... ft – acknowledge G-RF	G-RF	Procedure continues to published Missed Approach Point for AZ only approach
Undercarriage check	Check gear, acknowledge	Gear down, G-RF	Normally carried out between 3 and 4 nm from touchdown.  Not required for aircraft with fixed undercarriage
Clearance	Final clearance delayed, continue approach  Break off this approach – acknowledge .... (further instructions as required)	G-RF acknowledged (repeat of any further instructions)	Indicating that required clearance may be forthcoming  Specific instructions and reasons will be passed


### 1.13 **Military Aerodrome Traffic Zones (MATZ) and Penetration Services**


1.13.1 Comprehensive details of MATZ and the associated penetration service, including controlling aerodromes, contact frequencies and hours of watch, are contained in the UK AIP ENR Section, AICs, AIP Supplements or System NOTAM.


1.13.2 While every effort will be made to ensure safe separation, some civil aircraft flying within the MATZ may not be known to controllers and therefore pilots should keep a careful look-out at all times.


1.13.3 Pilots requiring a MATZ penetration service must establish two way RTF communication on the appropriate frequency with the aerodrome controlling the zone when 15 nm or 5 min flying time from the boundary whichever is the sooner. When requested by the controller to 'pass your message' the pilot should pass the following information:


- a) Aircraft Callsign / Type
- b) Departure Point and Destination
- c) Present Position
- d) Level
- e) Additional details / Intention (e.g. Flight Rules, Next Route Point)

 Westbury Approach G-ABCD request MATZ penetration

 G-ABCD Westbury Approach pass your message

 G-ABCD, Cessna 172, from Borton to Walden, Over Middleton, altitude 2500 feet Wessex 1005, VFR, tracking to Wells

 G-CD, cross MATZ at 1500 ft on Westbury QFE 1001. Report entering and leaving the MATZ

 Cross MATZ at 1500 ft on Westbury QFE 1001, Wilco G-CD

1.13.4 Whilst working a MATZ unit, pilots are expected to comply with any instructions issued by controllers and maintain a listening watch on the allocated RTF frequency. They should not change heading or level without giving prior warning and should advise when leaving the MATZ. At some MATZ units, the Zone controller is responsible for MATZ penetration services.

### 1.14 **Lower Airspace Radar Service (LARS)**

1.14.1 LARS is a radar service available to assist pilots flying outside controlled airspace up to and including FL 95. LARS is normally provided within 30 nm of the nominated unit and is a secondary service provided at the discretion of the controller. Therefore, when primary task loadings are high, LARS may not be available. The services available are **Radar Advisory Service (RAS)** or **Radar Information Service (RIS)**; the type of service required should be specified as per paragraph 1.14.4 below.


- 1.14.2 RAS is an air traffic service in which the controller will provide advice necessary to maintain prescribed separation between aircraft participating in the advisory service. The controller will also pass traffic information on conflicting non-participating traffic, together with advice on action necessary to resolve the conflict. **RAS is available only to IFR flights and controllers will expect the pilot to accept vectors or level allocations that may require flight in IMC.**

**NOTE:** Detailed conditions applicable to the provision of RAS are published in the UK AIP (ENR 1.6.1, Use of Radar in Air Traffic Services).

- 1.14.3 RIS is an air traffic service in which the controller will inform the pilot of the bearing, distance and, if known, the level of other traffic in the vicinity. No avoiding action will be offered. **The pilot is wholly responsible for avoiding collisions with other aircraft whether or not the controller has passed traffic information and for complying with appropriate rules (such as remaining in meteorological conditions or airspace in which the pilot is suitably qualified to fly).** The service may be requested under any flight rules or in-flight meteorological conditions.

**NOTE:** Detailed conditions applicable to the provision of RIS are published in the UK AIP (ENR 1.6.1, Use of Radar in Air Traffic Services).


- 1.14.4 Pilots requiring a LARS should establish RTF communication with the appropriate ATSU using the following format:

 Westbury Approach G-ABCD  
request Radar Information Service

 G-CD Westbury Approach Pass your  
message

- 1.14.5 Once communications have been established the pilot should pass the following details:

- Aircraft Callsign / Type
- Departure Point and Destination
- Present Position
- Level
- Additional details / Intention (e.g. Flight Rules, Next route point, Squawk Code)

 G-CD, Cessna 172, from Borton to  
Walden, 15 nm South of Westbury,  
altitude 2500 feet Wessex 1008,  
VFR, tracking to Wells, Squawking  
7000

- 1.14.6 A radar identification procedure does not imply that a radar service is being provided. The pilot must not assume that he is in receipt of a RAS or RIS until the controller has made a positive statement to that effect.










- 1.14.7 Details of ATSUs participating in the Lower Airspace Radar Service, hours of operation and contact frequencies, are published in the UK AIP (ENR 1.6.3, Lower Airspace Radar Service).

## Chapter 7 Area Phraseology

### 1 Area Control Service Phraseology









#### 1.1 General

The following examples of phraseology are suitable for use at area control centres according to the requirements of the prevailing traffic situation.

 Fastair 345 request descent	 Fastair 345 maintain FL 280 expect descent after Marlow
	 Maintaining FL 280 Fastair 345
 Fastair 345 descend FL 120. Cross Colinton FL 170 or above	 Descend FL 120. Cross Colinton FL 170 or above Fastair 345
 Fastair 345 are you able to cross Colinton at time 52	 Affirm Fastair 345
	 Fastair 345 cross Colinton 52 or before
	 Cross Colinton 52 or before Fastair 345

#### 1.2 Position Reporting

In order to assist in establishing separation, pilots may be instructed to provide additional position report information as well as routine reports.

 Fastair 345 report Colinton	 Fastair 345
 Fastair 345 Colinton 47 FL 170 descending FL 120, abeam KTN at 55	 Fastair 345
 Fastair 345 report 25 miles DME from Kennington	 Wilco Fastair 345
 Fastair 345 report your DME distance from Kennington	 Fastair 345 26 miles



Fastair 345 report passing radial  
270 Kennington VOR



Wilco Fastair 345

### 1.3 Flights Joining Airways

- 1.3.1 Aircraft requiring to join an airway should make their request to the appropriate ATSU. Where no flight plan has been filed, the request should include the filing of an airborne flight plan (see Chapter 3). Where a flight plan has already been filed an abbreviated call may be made.



Wrayton Control G-RDVC request  
clearance to enter controlled  
airspace northeast of Marlow at FL  
240 at time 42



G-RDVC cleared at time 42 from 8  
miles northeast of Marlow to  
Colinton via A1, maintain FL 240,  
squawk 5507



Cleared at time 42 from 8 miles  
northeast of Marlow to Colinton, via  
A1, maintain FL 240, squawk 5507  
G-RDVC



G-RDVC correct

- 1.3.2 Because of the prevailing traffic situation, a joining clearance may not be issued immediately.



G-RDVC remain outside controlled  
airspace expect joining clearance at  
time 55 time is 44



Remaining outside controlled  
airspace G-RDVC

- 1.3.3 In the event that the requested flight level is already occupied the controller will offer an alternative.



G-RDVC request FL 240



G-RDVC unable approve FL 240, FL  
220 available



G-RDVC accept FL 220

### 1.4 Flights Leaving Airways

- 1.4.1 Flights leaving controlled airspace will normally be given a specific point at which to leave, together with any other relevant instructions necessary to ensure separation.





G-RDVC cleared to leave controlled  
airspace northeast of Marlow at FL  
220 whilst in controlled airspace




Cleared to leave controlled airspace  
northeast Marlow at FL 220 in  
controlled airspace G-RDVC

### 1.4.2 An aircraft may request permission to leave controlled airspace by descent.

 G-RDVC request permission to leave controlled airspace by descent


 G-RDVC cleared to leave controlled airspace by descent. Report passing altitude 5500 feet the Wessex is 1014


 Cleared to leave controlled airspace by descent will report passing altitude 5500 feet the Wessex is 1014 G-RDVC


In the above example the base of the airway is 5500 feet.


### 1.5 Flights Crossing Airways


An aircraft requiring to cross an airway should make its request to the appropriate ATSU.

 Wrayton Control G-ABCD request crossing of A1 at Wicken

 G-ABCD Wrayton Control pass your message


 G-ABCD T67 from Borton, 20 miles north of Wicken heading 220 FL 80 IMC request crossing clearance of airway A1 at Wicken FL 80 at 1033


 G-ABCD cleared to cross A1 at Wicken, maintain FL 80 whilst in controlled airspace. Report entering the airway

 Cleared to cross A1 at Wicken maintain FL 80 in controlled airspace. Wilco. G-ABCD

### 1.6 Flights Holding En-Route

When an aircraft is required to hold en-route, the controller will issue holding instructions and a time at which onward clearance can be expected. Where it is not self-evident, the reason for the delay should also be given.

 Fastair 345 hold at Colinton FL 170, expect onward clearance at 03, landing delays at Kennington 20 minutes

 Hold at Colinton FL 170 expect onward clearance at time 03 Fastair 345



## 1.7 Reduced Vertical Separation Minimum (RVSM) Phraseology

1.7.1 The following phraseology is applicable for RVSM operations:

<b>Message</b>	<b>Phraseology (italics indicates a pilot transmission)</b>
To ascertain the RVSM approval status of a flight	CONFIRM RVSM APPROVED
Pilot indication of RVSM Approved status	<i>AFFIRM RVSM</i>
Pilot indication of non RVSM approval status	<i>NEGATIVE RVSM (supplementary information e.g. State aircraft)</i>
To deny ATC clearance into RVSM airspace	UNABLE ISSUE CLEARANCE INTO RVSM AIRSPACE, MAINTAIN [or DESCEND TO or CLIMB TO] (level)
For the case of an individual aircraft reporting severe turbulence or other severe weather related phenomenon	<i>UNABLE RVSM DUE TURBULENCE</i>
The phraseology required for a pilot to communicate those circumstances which would cause an aircraft's equipment to degrade to below altimetry Minimum Aircraft Systems Performance Specification (MASPS) compliance levels  Note: The phrase is to be used to convey both the initial indication of the non-altimetry MASPS compliance and, henceforth, on initial contact on all frequencies within the lateral limits of the RVSM airspace until such time as the problem ceases to exist	<i>UNABLE RVSM DUE EQUIPMENT</i>
To request an aircraft provide information as soon as RVSM approved status has been regained or the pilot is ready to resume RVSM operations	REPORT ABLE TO RESUME RVSM
To request confirmation that an aircraft has regained RVSM approved status or the pilot is ready to resume RVSM operations	CONFIRM ABLE TO RESUME RVSM
The pilot shall communicate his/her ability to resume operation within the RVSM airspace after an equipment related contingency, or his/her ability to resume RVSM operations after a weather related contingency	<i>READY TO RESUME RVSM</i>

**NOTE:** Should there be reason to believe that an aircraft's declared RVSM status is in doubt, then the controller shall ask the RVSM status in accordance with in the table above.

**Example:** A non-RVSM compliant aircraft maintaining FL350 making an initial call on a new frequency:

Pilot: (**callsign**) MAINTAINING FL350, NEGATIVE RVSM

- 1.7.2 During operations in, or vertical transit through, reduced vertical separation minimum (RVSM) airspace with aircraft not approved for RVSM operations, pilots shall report non-approved status at initial call on any channel within RVSM airspace.
- 1.7.3 Air traffic controllers shall explicitly acknowledge receipt of messages from aircraft reporting RVSM non-approved status.

## Chapter 8 Emergency Phraseology

### 1 Distress and Urgency Communication Procedures

#### 1.1 Introduction

This chapter describes the characteristics of the VHF International Aeronautical Emergency Service and the RTF procedures which should be used under the Aeronautical Mobile Service during an emergency in the UK. Additional information is published in the UK AIP (GEN) section and AICs.

#### 1.2 States of Emergency

1.2.1 The states of emergency are classified as follows:

- a) *Distress* A condition of being threatened by serious and/or imminent danger and of requiring immediate assistance.
- b) *Urgency* A condition concerning the safety of an aircraft or other vehicle, or of some person on board or within sight, but does not require immediate assistance.

1.2.2 The pilot should make the appropriate emergency call as follows:

- a) *Distress* 'MAYDAY, MAYDAY, MAYDAY'
- b) *Urgency* 'PAN PAN, PAN PAN, PAN PAN'

#### 1.3 VHF Emergency Service

1.3.1 The UK has two Distress and Diversion (D&D) Sections located at the London and Scottish Area Control Centres. They are manned by RAF control staff who are assisted in the provision of an emergency service on the International Aeronautical Emergency Frequency 121.50 MHz by suitably equipped civil and military units and certain HM Coastguard stations. The service is available continuously to pilots flying within UK airspace who are in distress, in urgent need of assistance, or experiencing difficulties, (i.e. temporarily unsure of position) which could lead to a state of emergency. The service may also be available for practices provided that no actual emergency is in progress on the UHF or VHF distress frequencies. More information on the emergency service for civil pilots can be found in the UK AIP (GEN).

1.3.2 The primary role of the D&D Sections is to provide military and civil pilots with an emergency aid and position fixer service. Autotriangulation (DF) coverage on 121.5 MHz is available over most of the London FIR above 2000 ft amsl to aircraft flying to the east and south of Manchester. In respect of other civil aircraft incidents on VHF they rely for position fixing on DF bearing information obtained by telephone from external units equipped with VDF. This fixing procedure takes time and may require several minutes of concentrated activity because it involves the manual plotting onto 1:250,000 charts of the bearings received. The quality of the position fixes is determined by the availability of VDF bearings, and thus, depends largely on the height of an aircraft and its distance from the VDF stations. The coverage of the VHF fixing service is limited below 3000 ft amsl; indeed, the ability to locate aircraft at low altitude by the use of VDF may be severely inhibited (because of the effects of high ground) over much of Scotland, Wales and SW England. In circumstances where 121.5 MHz DF data is lacking, the controller's ability to assist a pilot who is uncertain of his position is very limited, and will depend on such factors as the availability of SSR information and the amount and accuracy of the information provided by the pilot about his route, last known position and observed landmarks.

1.3.3 Certain UK aerodromes can also offer civil pilots an effective emergency communications and aid service. Some maintain a continuous watch on 121.50 MHz, but not all are equipped with VDF or SSR. Others do not normally listen out on 121.50 MHz but they do have VDF and may be asked by the Emergency Controller to provide DF bearing information on an aircraft, and other assistance. Where a bearing is required for fixing purposes from an airfield which has VDF but not on 121.5 MHz, the Emergency Controller may instruct the pilot to change temporarily to the frequency on which VDF is available.

#### 1.4 **VHF Emergency Service – General Procedures**

1.4.1 Pilots should address their emergency calls on 121.50 MHz to 'London Centre' when south of N55°, and 'Scottish Centre' when north of N55°. If doubt exists about the appropriate centre, it is not necessary to address a specific station. Once two-way communication has been established, pilots should not leave 121.5 MHz without telling the controller. The use of special D&D Sections at the ACCs in the provision of emergency services is unique to the UK. Detailed information on related UK Search and Rescue (SAR) procedures is contained in the GEN Section of the UK AIP.

1.4.2 Pilots are urged – in their own interests – to request assistance from the emergency service as soon as there is any doubt about the safe conduct of their flight. Even then, the provision of assistance may be delayed if a pilot does not pass clear details of his difficulties and requirements, using the international standard RTF prefix 'MAYDAY, MAYDAY, MAYDAY' or 'PAN PAN, PAN PAN, PAN PAN' as appropriate. For example, a vague request from a pilot for 'confirmation of position' is unlikely to be accorded as much priority as would be given to a statement that he is lost. If, subsequent to the transmission of a 'MAYDAY' or 'PAN', a pilot considers the problem not to be as serious as first thought and priority attention is no longer required, the emergency condition may be cancelled at the pilot's discretion. It is invariably preferable for pilots believing themselves to be facing emergency situations to declare them as early as possible and then cancel later if they decide the situation allows.

1.4.3 If a pilot is already in communication with a civil or military ATSU, before the emergency arises, assistance should be requested from the controller on the frequency in use. In this case, any SSR code setting previously assigned by ATC (other than the Conspicuity Code 7000) should be retained until instructions are received to change the code setting.

1.4.4 If, however, the pilot is not in direct communication with an ATSU and the aircraft is equipped with an SSR transponder it should be switched, preferably before the emergency call is made, to Emergency Code 7700, with Mode C if available. If the transponding aircraft is high enough to be within secondary radar cover, the selection of the Emergency 7700 Code will alert the Emergency Controller to the presence of an incident by means of an audio and visual warning. The received SSR plot will show the precise location of the aircraft on the controller's radar display, and will then obviate the need for the emergency controller to carry out the more time-consuming manual aircraft position plotting procedure. Information on SSR operating procedures, including Special Purpose Codes 7700 (Emergency), 7600 (Radio Failure) and 7500 (Hijack or Other Act of Violence) are detailed in the ENR Section of the UK AIP.

1.4.5 If no acknowledgement of the distress or urgency message is made by the station addressed by the aircraft, other stations shall render assistance. Due to the nature of distress and urgency situations, the originator of messages addressed to an aircraft in distress or urgency condition shall restrict to the minimum the number and volume and content of such messages as required by the condition.





## 1.5 Emergency Message

The emergency message shall contain the following information (time and circumstance permitting) and, whenever possible, should be passed in the order given:

- a) 'MAYDAY/MAYDAY/MAYDAY' (or 'PAN PAN/PAN PAN/PAN PAN');
- b) Name of the station addressed (when appropriate and time and circumstances permitting);
- c) Callsign;
- d) Type of aircraft;
- e) Nature of the emergency;
- f) Intention of the person-in-command;
- g) Present or last known position, flight level/altitude and heading;
- h) Pilot qualifications (See Note 1), viz:
  - i) Student pilots (see Note 2);
  - ii) No Instrument Qualification;
  - iii) IMC Rating;
  - iv) Full Instrument Rating.
- i) Any other useful information e.g. endurance remaining, number of people on board (POB) etc.

### NOTES:

- 1 There is no ICAO requirement to include pilot qualifications in a distress message. However, this information should be included whenever possible in UK emergency messages as it may help the controller to plan a course of action best suited to the pilot's ability.
- 2 Inexperienced civil pilots communicating with a military unit or the D&D Section may consider prefixing their callsign with the codeword 'TYRO', to indicate their lack of experience. (See Chapter 10, Phraseology Examples, paragraph 1.7.)
- 3 POB – Total number of People on Board.

 <p>MAYDAY MAYDAY MAYDAY Milthorpe Tower G-ABCD Slingsby engine fire losing height intend an immediate forced landing 20 miles south of Milthorpe. Passing 3000 feet heading 360 PPL no instrument qualification 1 POB</p>	 <p>G-ABCD Milthorpe Tower roger MAYDAY ..... (any pertinent information)</p>
 <p>MAYDAY MAYDAY MAYDAY Milthorpe Tower G-ABCD C172 engine failed. Will attempt to land Milthorpe, 10 miles south, 4000 ft heading 360 Student pilot</p>	 <p>G-ABCD Milthorpe Tower roger MAYDAY cleared straight-in runway 35 wind 260 10 knots QFE 1008 you are number one</p>

## 1.6 **Speechless Code**

- 1.6.1 If an emergency message received by the Military Emergency Controller is weak or distorted to the point of being unintelligible, the pilot may be asked to adopt the Speechless Code. This entails the pilot pressing his transmit button a certain number of times and using carrier wave only transmissions which, by convention, have the following code meanings:


**Table 16**

<b>Number of transmissions</b>	<b>Meaning</b>
One Short	'Yes' or an acknowledgement
Two Short	'No'
Three Short	'Say again' (to be used by the pilot when he has not fully heard the controller's transmission, or has not understood the transmission, or the transmission was an instruction and the pilot is unable to comply).
Four Short (letter H in morse)	'Request Homing' (to an airfield), or used for initial alerting. (A civil pilot should only use the four short transmissions if he is aware, or suspects before attempting to make initial contact with the Emergency Controller, that his own aircraft microphone is unserviceable. The Emergency Controller will then interrogate the pilot, using the callsign 'Speechless Aircraft' if the identity of the aircraft is unknown).
One Long (2 secs)	'Manoeuvre Complete' (e.g. steady on heading).
One Long, Two Short and One Long (---) (letter X in morse)	'My aircraft has developed another emergency'

- 1.6.2 An aircraft SSR transponder can also be used, during times of communication difficulties, by a pilot to acknowledge or respond to messages by the transmission of SSR Code changes or squawking 'Ident' as requested by the controller.
- 1.6.3 If neither the state of DISTRESS nor URGENCY applies, a service is available at lower priority to pilots who find themselves in DIFFICULTY. Such pilots should make their situation clear and then provide as much information as possible to the emergency controller from the list at paragraph 5.1 (a) to (i).

## 1.7 **Radio Procedures – Practice Emergencies**

- 1.7.1 Pilots may simulate emergency incidents (BUT NOT THE STATE OF DISTRESS) on 121.50 MHz to enable them to gain experience of the ATC service provided. Before calling, pilots should listen out on the emergency frequency to ensure that no actual or practice incident is already in progress. Practice calls need not disrupt a planned flight or involve additional expense in fuel or time since the pilot can request 'diversion' to his intended destination or cancel the exercise when necessary. Simulated emergency calls must be prefixed 'PRACTICE' and should be brief, e.g:

 'PRACTICE PAN, PRACTICE PAN,  
PRACTICE PAN, LONDON CENTRE  
G-ABCD'

The Emergency Controller will then indicate acceptance of the Practice Pan by transmitting:

 G-ABCD, LONDON CENTRE  
CONTINUE WITH PRACTICE PAN'


The Emergency Controller may instruct the pilot to call at another time, if the practice cannot be accommodated.

- 1.7.2 If a practice is accepted, the pilot should then pass his details. SSR Code 7700 should *not* be selected during a practice emergency exercise unless required by the Emergency Controller. Mode C should be switched on, if available.

### 1.8 Training Fix

Pilots who do not wish to carry out a practice emergency but only wish to confirm their position may request a 'Training Fix' on 121.5 MHz. This 'Training Fix' is secondary in importance to actual emergency calls but takes precedence over practice emergency calls in the event of simultaneous incidents.


(Listen out before transmitting)


 Training Fix, Training Fix, Training  
Fix, G-ABCD

 G-ABCD, Scottish Centre your  
position is 7 miles south of Pitlochry

### 1.9 Relayed Emergency Message

Any aeronautical station or aircraft knowing of an emergency incident may transmit a distress message whenever such action is necessary to obtain assistance for the aircraft or vessel in distress. In such circumstances, it should be made clear that the aircraft transmitting is not itself in distress.

 MAYDAY MAYDAY MAYDAY  
Milthorpe Tower G-ABCD have  
intercepted MAYDAY from G-BJRD  
I say again G-BJRD Cessna 172  
engine failure forced landing 10  
miles west of Wicken VOR, 1000  
feet descending, heading 120, IMC  
rating, over

 G-ABCD Milthorpe Tower Roger  
your relayed MAYDAY from G-BJRD

### 1.10 Imposition of Silence


- 1.10.1 Transmissions from aircraft in distress have priority over all other transmissions. On hearing a distress call, all stations must maintain radio silence on that frequency unless the distress is cancelled or the distress traffic is terminated; all distress traffic has been transferred to other frequencies; the station controlling communications gives permission; it has itself to render assistance. Any station which has knowledge of distress traffic, and which cannot itself assist the station in distress, shall nevertheless continue listening to such traffic until it is evident that assistance is

being provided. Stations should take care not to interfere with the transmission of urgency calls.


- 1.10.2 The aircraft in distress or the station in control of a distress incident may impose silence either on all stations in the area or on any particular station that interferes with distress transmissions. In either case, the message should take the following form:

 All stations Milthorpe Tower stop transmitting. MAYDAY

or,


 G-ABCD stop transmitting. MAYDAY


- 1.10.3 The aeronautical station acknowledging a distress message on a particular frequency may consider it prudent to transfer other aircraft from that frequency in order to avoid any disruption of transmission from or to the emergency aircraft.


 MAYDAY G-BJRD. All other aircraft contact Milthorpe Tower on 123.8, out

#### 1.11 Termination of Distress Communications and of RTF Silence

- 1.11.1 When an aircraft is no longer in distress it shall transmit a message cancelling the emergency condition.

 Milthorpe Tower G-BJRD cancel MAYDAY, engine restarted, runway in sight. Request landing

 G-RD runway 35 cleared to land.  
Surface wind 320 6

 Runway 35 cleared to land G-RD

- 1.11.2 When an distress incident has been resolved, the station which has been controlling the emergency traffic will transmit a message indicating that normal working may be resumed.

 All stations Milthorpe Tower distress traffic ended





## Chapter 9 Miscellaneous Phraseology

### 1 Other Communications


#### 1.1 Wake Vortex


- 1.1.1 ATC will provide the appropriate spacing between IFR flights but, if a pilot elects to execute a visual approach, or is arriving as a VFR flight, it is his responsibility to provide adequate spacing, although ATC will pass the appropriate distance.

 G-BJCD caution vortex wake the recommended spacing is (number) miles

 G-BJCD

- 1.1.2 For departing flights ATC will issue take-off clearance when the required wake vortex spacing minima will be achieved. The minima to be applied at the time the aircraft are airborne is dependent on aircraft sequence, wake vortex categories, and runway departure configuration.


 G-BJCD, Ready

 G-BJCD Hold position, (number) minutes delay due to vortex wake

 Holding G-BJCD

#### 1.2 Wind Shear

When wind shear is forecast or is reported by aircraft, ATC will warn other aircraft until such time as aircraft report the phenomenon no longer exists. .

 G-CD at 0745 a departing B757 reported windshear at 800 feet. Airspeed loss 20 kts, strong right drift

#### 1.3 AIRPROX Reporting

- 1.3.1 An AIRPROX Report should be made by any pilot flying in the United Kingdom Flight Information Region, the Upper Flight Information Region or Shanwick Oceanic Area when in his opinion, the distance between aircraft as well as their relative positions and speed have been such that the safety of the aircraft involved was or may have been compromised.
- 1.3.2 The initial report is made by RTF to the ATSU in communication with the aircraft except that if the controllers workload is such that he is not able to accept the report the pilot will be requested to file details after landing.
- 1.3.3 The Pilot's RTF report should commence with words 'AIRPROX REPORT' and should include the following items:

Aircraft Callsign

SSR Code

Position of AIRPROX  
Aircraft heading  
Flight level, altitude or height  
Altimeter setting  
Aircraft attitude (level/climbing/descending/turning)  
Weather conditions  
Date and time (UTC) of the AIRPROX  
Description of other aircraft  
First sighting distance and details of flight paths of reporting and reported aircraft.

- 1.3.4 RTF AIRPROX reports are to be confirmed in writing within seven days of the incident to allow follow up action to be taken. (See UK AIP ENR Section.)

#### 1.4 **Oil Pollution Reporting**

Pilots sighting substantial patches of oil are requested to make reports by RTF to the ATSU with whom they are in communication or the appropriate FIS in order that action can be taken.

The RTF reports should contain the following:

'OIL POLLUTION REPORT' or 'POLLUTION REPORT'

- . . . Time and date (if required) pollution was observed and identify of reporting aircraft.
- . . . Position and extent of pollution
- . . . Tide, windspeed and direction
- . . . Weather conditions and Sea state
- . . . Characteristics of pollution
- . . . Name and nationality or description, including any distinctive markings, of any vessel seen discharging oil or other harmful substances; also estimated course and speed of vessel and if pollution is observed ahead of the discharging ship and the estimated length of pollution in her wake
- . . . Identity of any other vessels in the immediate vicinity
- . . . Whether photographs taken.

#### 1.5 **Interceptions by Military Aircraft**

Pilots are warned that should they become involved in an interception by military aircraft they should follow the international procedures as detailed in the UK AIP ENR Section.

#### 1.6 **Aircraft Operating Agency Messages**

##### 1.6.1 **Introduction**

An aeronautical radio station which is licensed and established for company operational control communications (OPC) may be used only for communication with company aircraft or aircraft for which the company is the operating agency. A radio operator's certificate of competence issued by the UK CAA is not required for the use of this radio station.

## 1.6.2 Limitations

Personnel authorised to use an aircraft operating agency radio must not hold themselves out as providing an air traffic control service i.e. they must not pass instructions to aircraft which could be construed in any way to be such a service. Similar constraints apply with regard to flight information services provided by a FISO for specific ground movements at aerodromes. Flight safety messages must be confined to messages originated by the agency which are of immediate concern to an aircraft in flight or just about to depart. This may include meteorological information.

1.6.3 Aircraft operating agency radio stations may only transmit and receive flight regularity and flight safety messages.

1.6.4 Air traffic service units using direct pilot-controller communication channels shall only be required to handle flight regularity messages provided this can be achieved without interference with their primary role and no other channels are available for the handling of such messages.

1.6.5 Flight regularity messages comprise the following:

- a) Messages regarding the operation or maintenance of facilities essential for the safety or regularity of aircraft operation.
- b) Messages concerning the servicing of aircraft.
- c) Instructions to aircraft operating agency representatives concerning changes in requirements for passengers and crew caused by unavoidable deviations from normal operating schedules. Individual requirements of passengers or crew are not admissible in this type of message.
- d) Messages concerning non-routine landings to be made by the aircraft.
- e) Messages concerning aircraft parts and materials urgently required.
- f) Messages concerning changes in aircraft operating schedules.

1.6.6 Flight safety messages shall comprise the following:

- a) Movement and control messages (e.g. flight plans, clearances),
- b) Messages originated by an aircraft operating agency, or by an aircraft, of immediate concern to an aircraft in flight,
- c) Meteorological advice of immediate concern to an aircraft in flight or about to depart (individually communicated or for broadcast),
- d) Other messages concerning aircraft in flight or about to depart.

1.6.7 It is permissible for aircraft operating agency messages to be handled by the aerodrome communication facility provided this can be achieved without interference with its primary role and no other channels are available for the handling of such messages.

1.6.8 Public correspondence messages are not permitted on VHF frequencies in the aeronautical mobile service.

## 1.7 8.33 kHz Phraseology


1.7.1 As a solution to severe VHF spectrum congestion, ICAO has split the VHF communications band from 25 kHz to 8.33 kHz channel spacing.


1.7.2 8.33 kHz frequencies are referred to as 'channels'.

1.7.3 There is a sixth digit at the end of the channel designation and when transferring between channels all six digits must be used.


1.7.4 The following phraseology shall only be used when referring to 8.33 kHz channels.

1.7.5 To request the capability of the radio equipment:


 **Fastair 345 confirm eight point three three**


 **Fastair 345 affirm eight point three three**

or


 **Fastair 345 negative eight point three three**

1.7.6 To request UHF capability:


 **Fastair 345 confirm UHF**

 **Fastair 345 affirm UHF**

or


 **Fastair 345 negative UHF**

1.7.7 To request the status regarding exemption:


 **Fastair 345 confirm eight point three three exempted**

 **Fastair 345 affirm eight point three three exempted**


or


 **Fastair 345 negative eight point three three exempted**

1.7.8 To indicate that a certain clearance is given because otherwise a non-equipped aircraft would enter the airspace of mandatory carriage.











 **Fastair 345 (Clearance/Instruction)  
Due eight point three three  
requirement**

1.7.9 To request the pilot confirm the 8.33 selection.

 **Fastair 345 confirm eight point three three channel (name)**

 **Fastair 345 affirm eight point three three channel (name)**

## 1.7.10 Transfer of control and/or change channel.

	 <b>Fastair 345</b> contact (unit callsign) channel (name)	
	 <b>Fastair 345</b> at (or over) (time or place) contact (unit callsign) channel (name)	
	 <b>Fastair 345</b> if no contact (instructions)	
	 <b>Fastair 345</b> stand by channel (name) for (unit callsign)	
	 <b>Fastair 345</b> request change to channel (name)	 <b>Fastair 345</b> channel change approved
	or	
	 <b>Fastair 345</b> monitor (unit callsign) channel (name)	 <b>Fastair 345</b> monitoring channel (name)
	or	
	 <b>Fastair 345</b> when ready contact (unit callsign) channel (name)	
	or	
	 <b>Fastair 345</b> remain this channel	

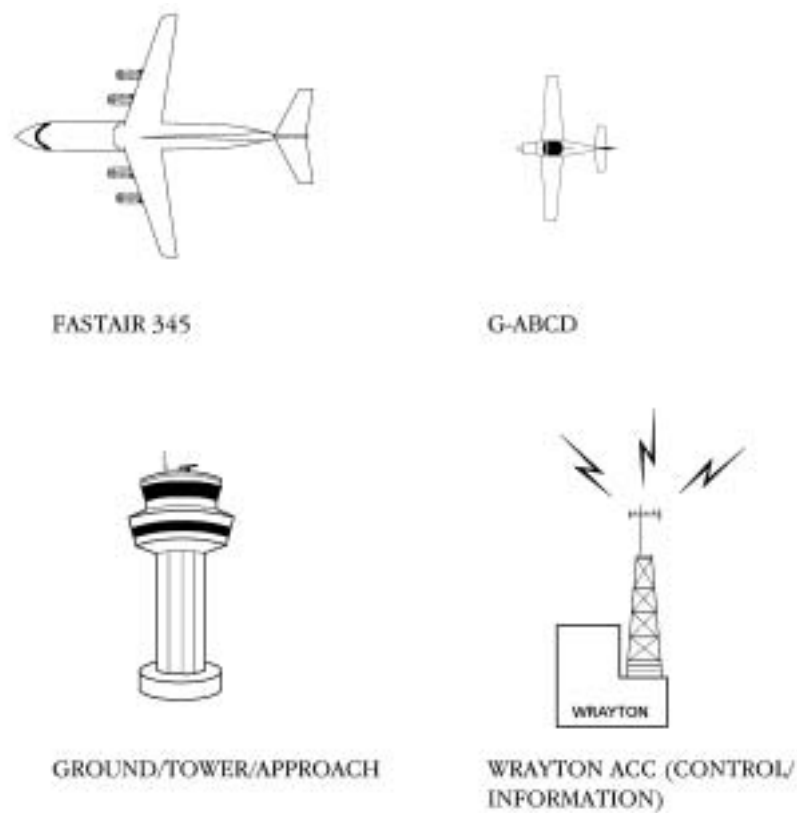
1.7.11 When transferring an aircraft to a non 8.33 kHz sector, current frequency change phraseology shall be used.

# Chapter 10 Phraseology Examples

## 1 Examples of Types of Flights

### 1.1 Introduction

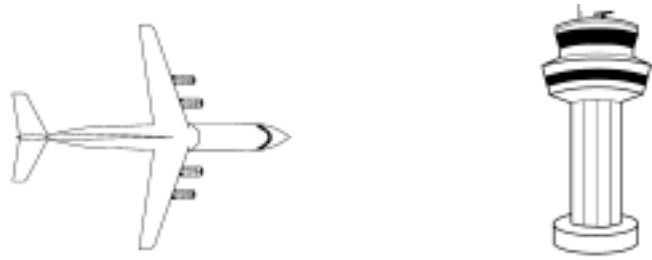
An example of an IFR flight from one major airport to another, and an example of a VFR flight from a provincial aerodrome to a landing site, are given in graphic form in this chapter. The latter then changes to an IFR flight on departure again to illustrate the differences between RAS and RIS (see Chapter 6). The agencies are described in Figure 4.



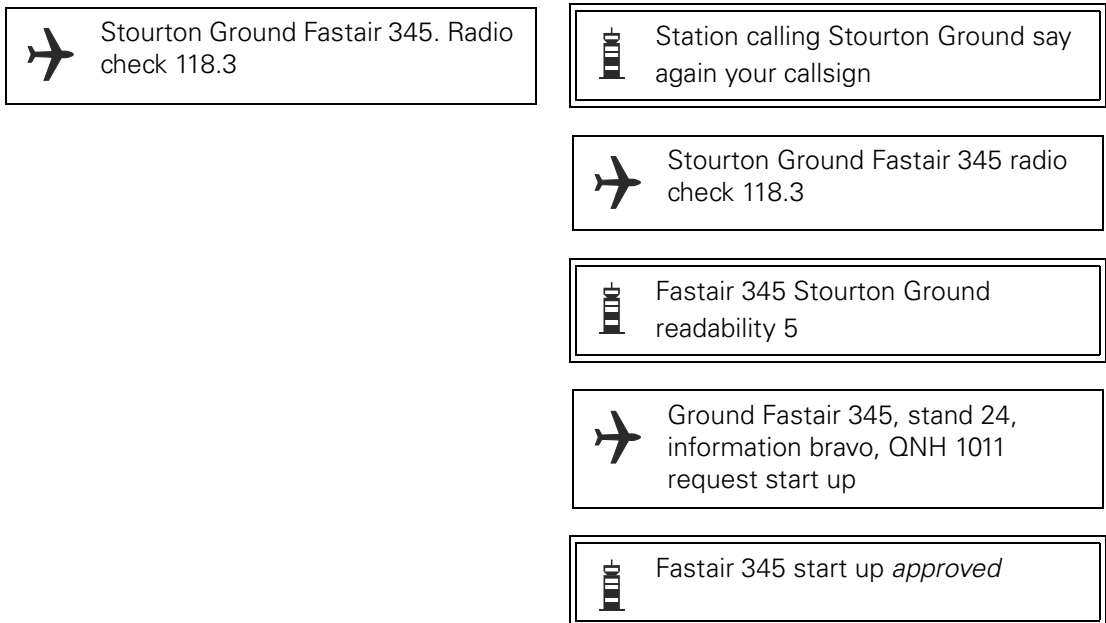
**Figure 4** Diagram Key

1.2 **An IFR Flight**

1.2.1 **Start up**



**Figure 5** IFR – Start Up Approval

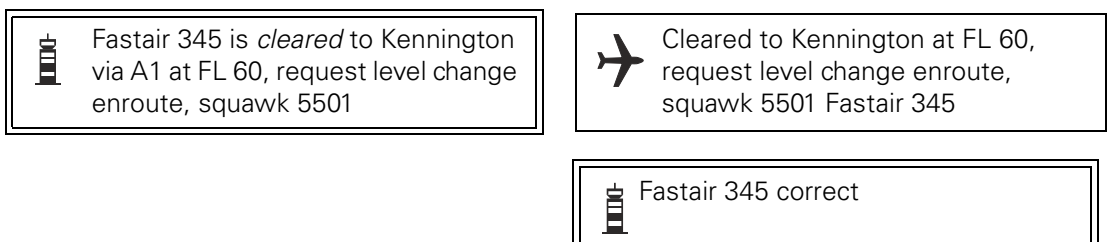


**NOTE:** The word 'APPROVED' is used - not 'CLEARED'.

1.2.2 **ATC Clearance**



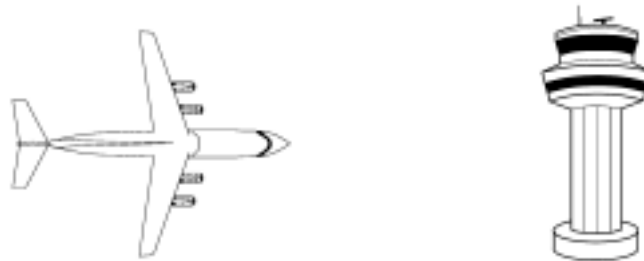
**Figure 6** IFR – ATC Clearance



**NOTES:**

- 1 The word CLEARED is introduced.
- 2 A full readback of a clearance is required – see paragraph 2.4 below.

1.2.3 **Pushback and Taxi**



**Figure 7** IFR – Pushback Approval

Ground Fastair 345 request pushback	Fastair 345 pushback approved
-------------------------------------	-------------------------------

**NOTE:** The word 'APPROVED' is used - not 'CLEARED'.

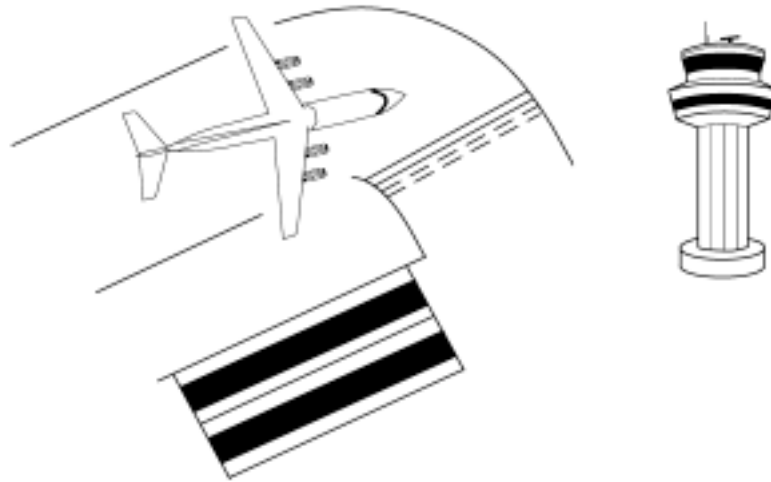


**Figure 8** IFR – Taxi Instructions

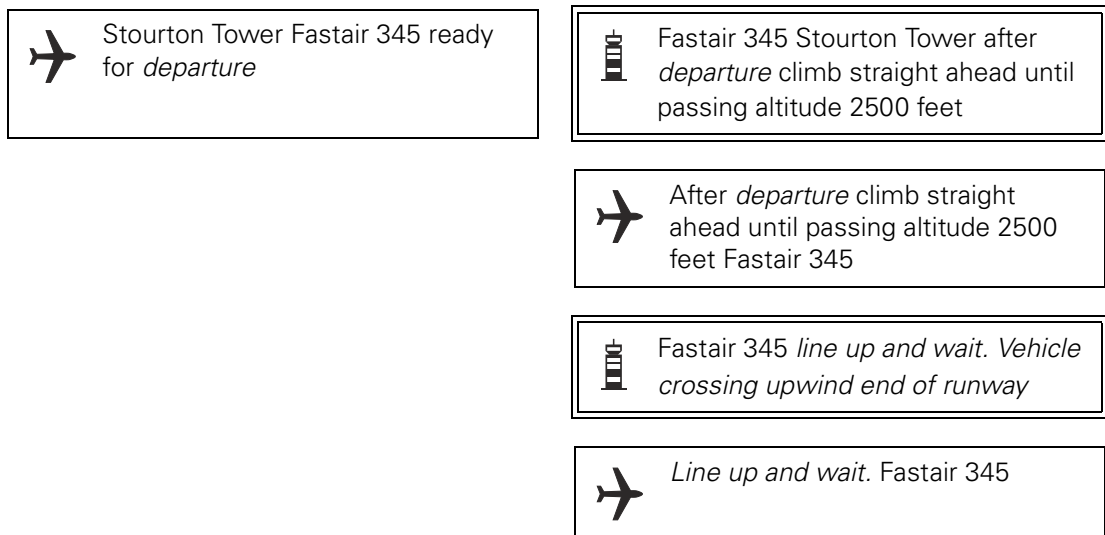
Ground Fastair 345 information Charlie QNH 1011 request taxi	Fastair 345 taxi holding point G2 runway 24
	Taxi holding point G2 runway 24 Fastair 34
	Fastair 345 contact Stourton Tower 118.9
	Stourton Tower 118.9 Fastair 345



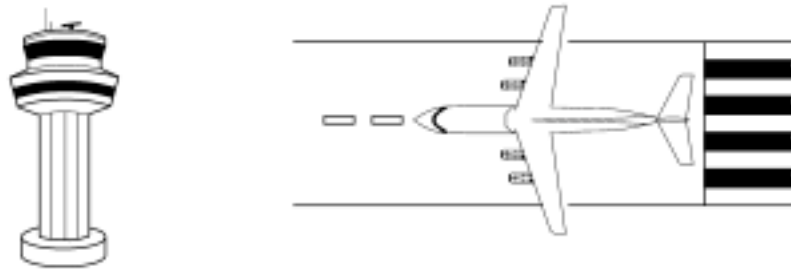
## 1.2.4 Pre-departure and Take-off




**Figure 9** IFR – Departure Instructions and Line-up (i)


**NOTES:**

- 1 'DEPARTURE' employed and not 'TAKE-OFF'.
- 2 'CLEARED' is not used in these cases – see next 'Notes'.
- 3 Full readback is required for instructions to ENTER, LAND, TAKE-OFF ON, BACKTRACK, HOLD SHORT OF, OR CROSS a runway.
- 4 'LINE UP AND WAIT' (plus reason) is employed; 'LINE UP' (only) may also be used.



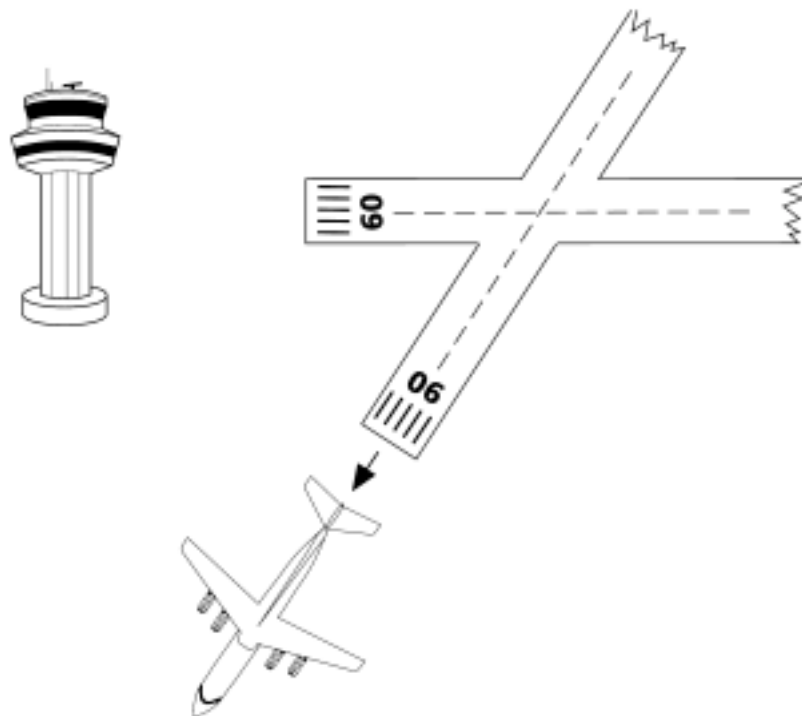
**Figure 10** IFR – Take-off Clearance

 Fastair 345 cleared for take-off surface wind calm


 Cleared for take-off Fastair 345


**NOTES:**

- 1 TAKE-OFF – these words are *only* used when an aircraft is cleared for TAKE-OFF.
- 2 TAKE-OFF clearance requires readback.
- 3 Use of CLEAR is restricted to:
  - i) ATC clearances.
  - ii) Departure and Approach instructions.
  - iii) Take-off and landing clearances.



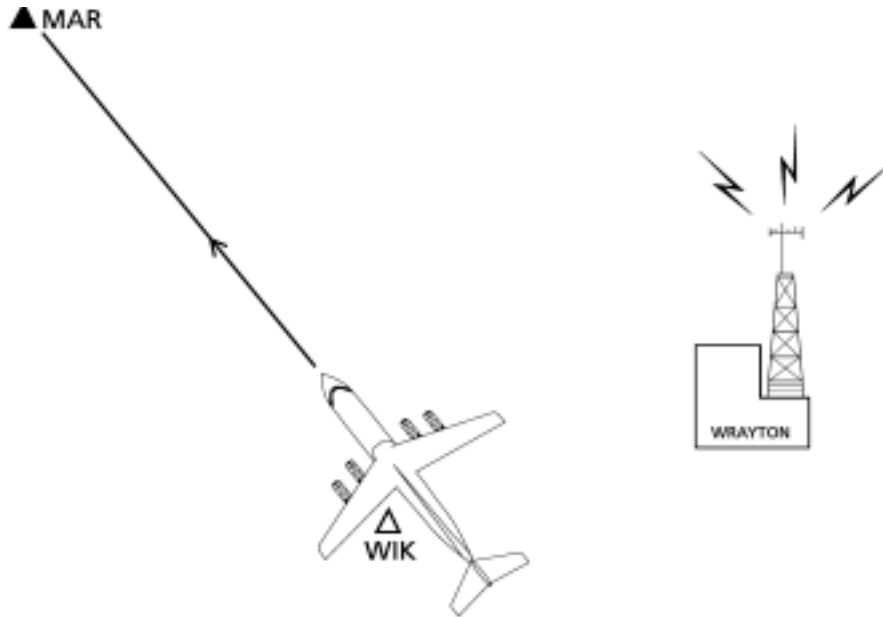
**Figure 11** IFR – Airborne Report

 Fastair 345 contact Wrayton control 129.1


 Wrayton Control 129.1 Fastair 345


**NOTE:** Full readback of frequency change.





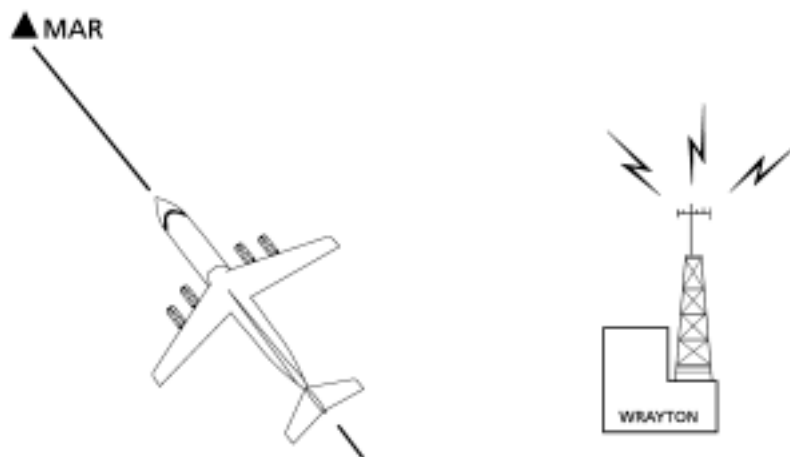
**Figure 13** IFR – Position Report

 Fastair 345 Wicken 47 FL 130 climbing FL 280 Marlow 07


 Fastair 345 Roger

**NOTE:** Position report consists of:

- a) Aircraft identification.
- b) Position.
- c) Time.
- d) Level.
- e) Next position and ETA.

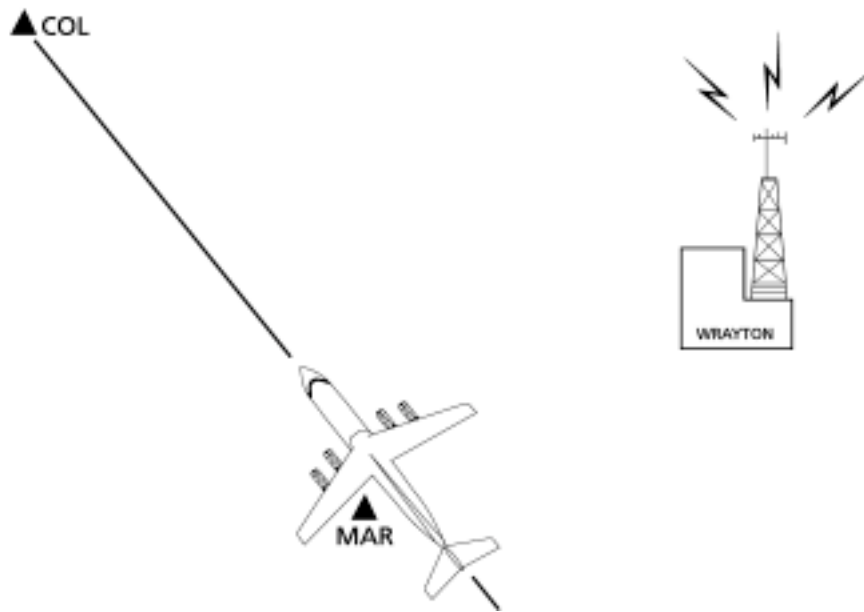


**Figure 14** IFR – Level Report


 Fastair 345 reaching FL 280

 Fastair 345

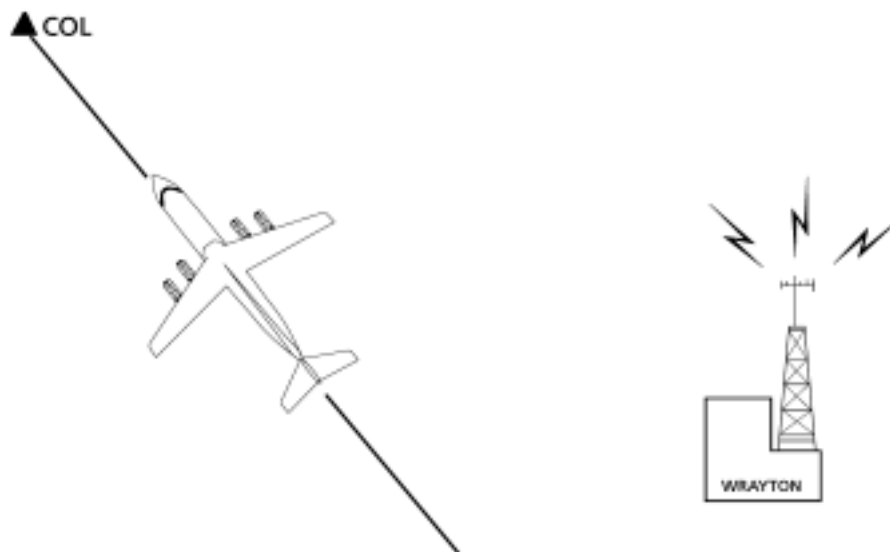
**NOTE:** For passing instructions/reports regarding height/altitude or flight level, use CLIMB(ING), DESCEND(ING), PASSING, REACHING or LEAVING but *not* CLEARED/RE-CLEARED.




**Figure 15** IFR – Position Report


 Fastair 345 Marlow 08 FL 280  
Colinton 48


 Fastair 345

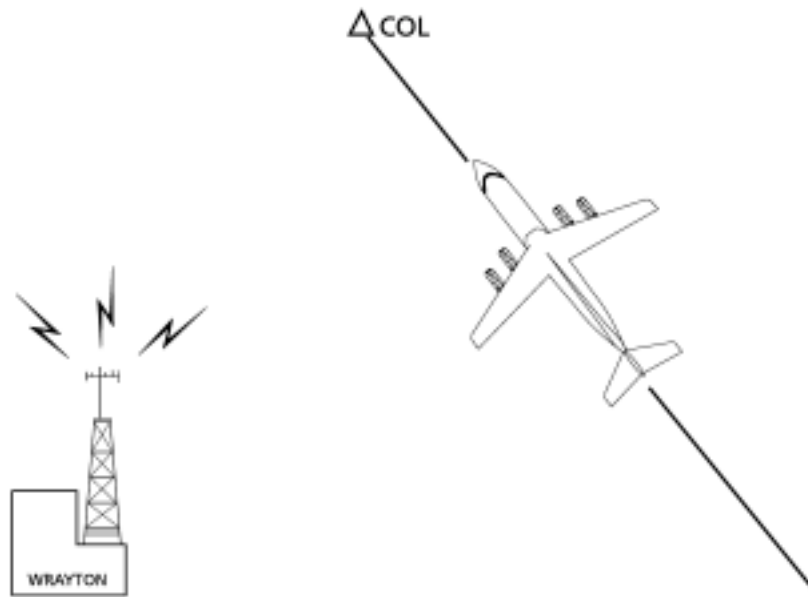


**Figure 16** IFR – Descent Clearance

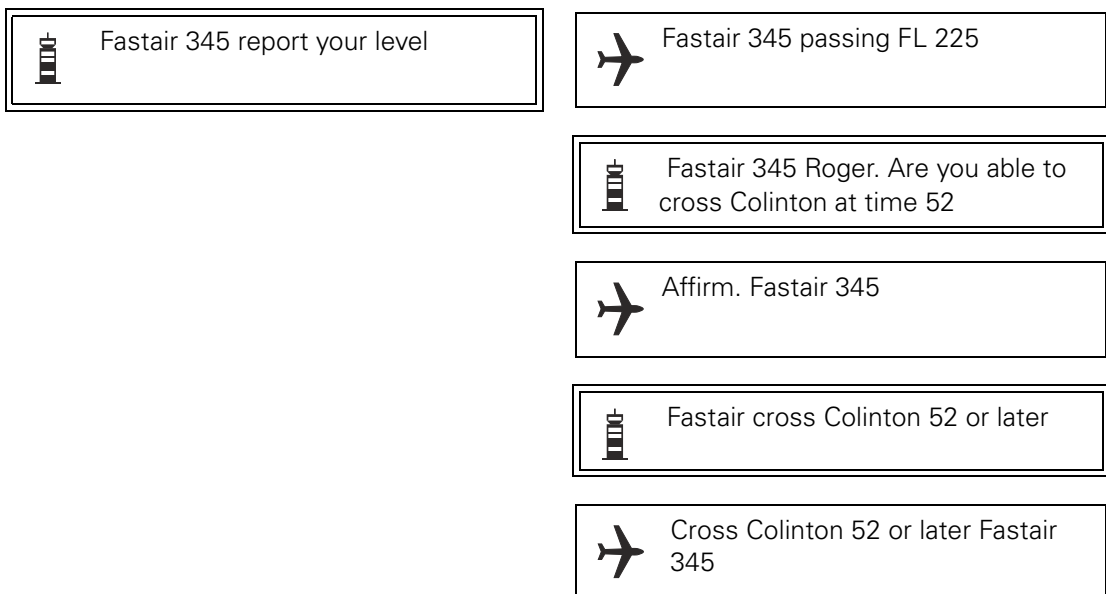
 Fastair 345 request descent

 Fastair 345 descend FL 120 cross  
Colinton FL 170 or above

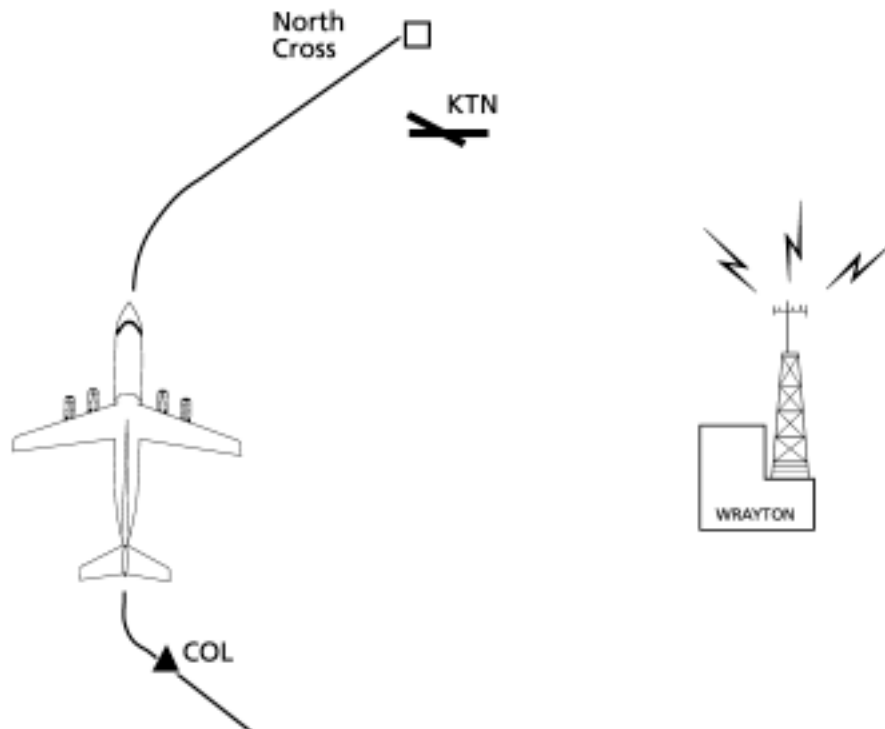
 Descending FL 120 will cross  
Colinton FL 170 or above Fastair  
345



**Figure 17** IFR – ATC Request and Instruction



**NOTE:** AFFIRM/NEGATIVE are used when a question requires a direct answer.

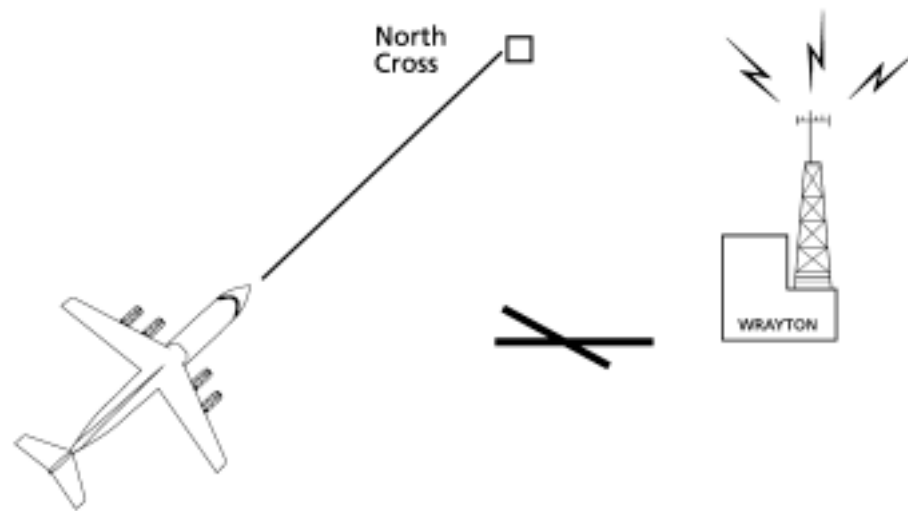


**Figure 18** IFR – Pilot Request

✈ Fastair 345 Colinton 52 FL 180 descending FL 120 request direct North Cross for ILS approach at Kennington

📻 Fastair 345 Roger. Route direct to North Cross. Descend FL 60. Report West abeam KTN

✈ Direct North Cross descend FL 60. Wilco Fastair 345



**Figure 19** IFR – Descent to FL 100

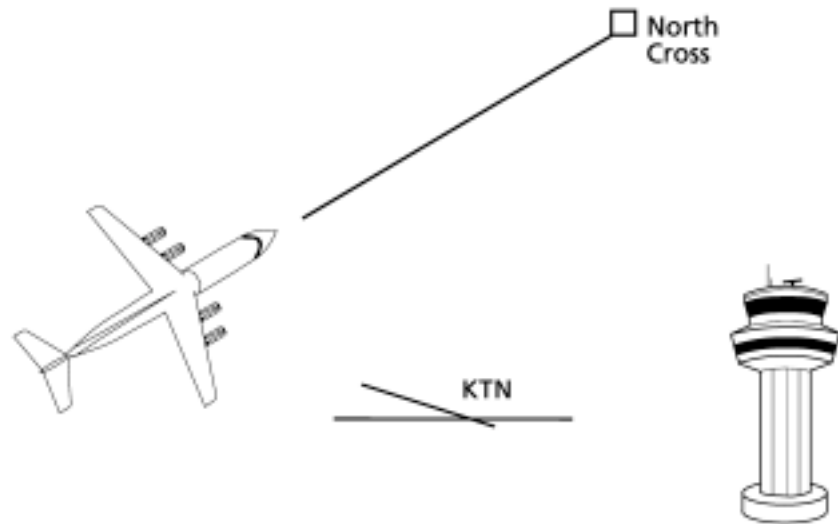
✈ Fastair 345 West abeam  
Kennington 03 FL 100 descending  
FL 60 North Cross 11

📻 Fastair 345 Roger. Contact  
Kennington Approach 119.7

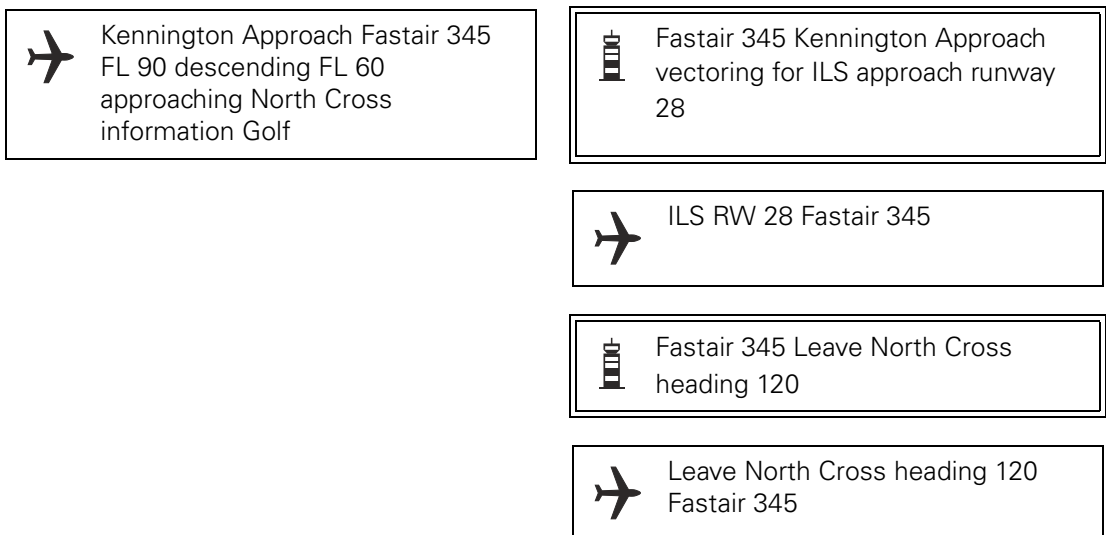
✈ Kennington Approach 119.7 Fastair  
345

**NOTE:** FL 100 spoken as “flight level WUN HUN DRED”





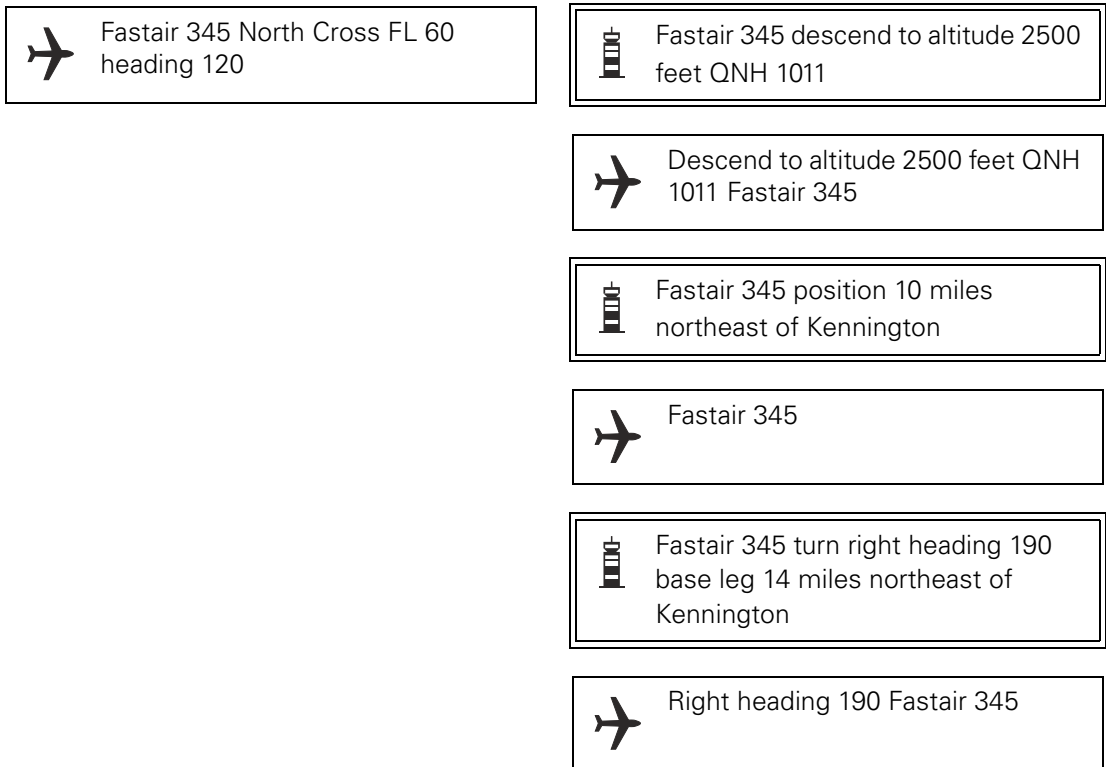
**Figure 20** IFR – Contacting Approach Control



**NOTE:** Full readback of HEADING (and speed) instructions; also runway identifier.

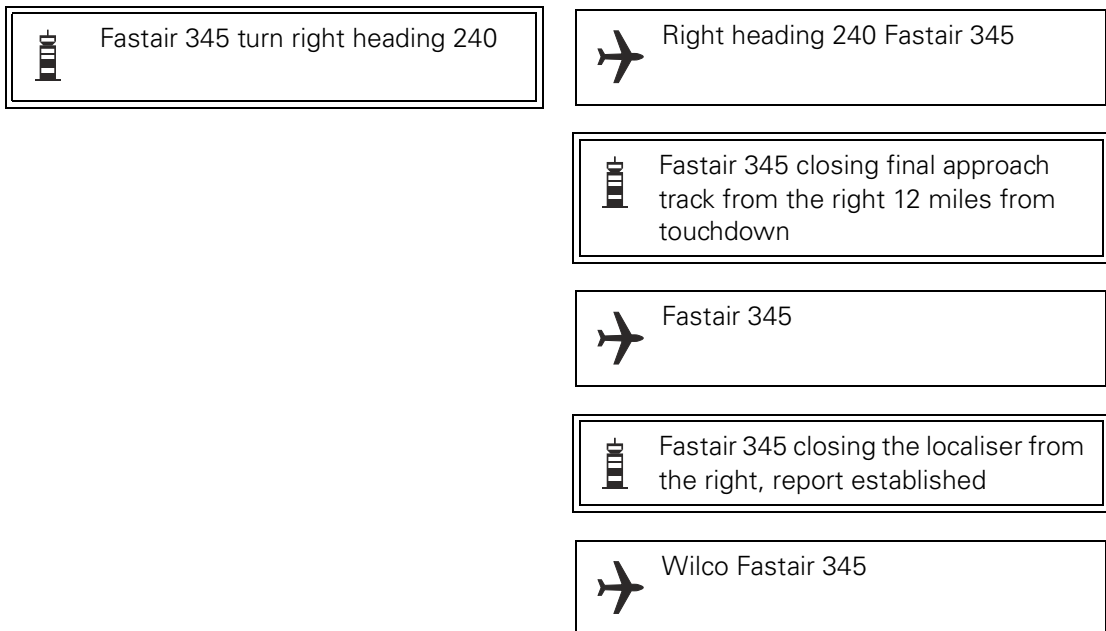


**Figure 21** IFR – Vectoring for Approach



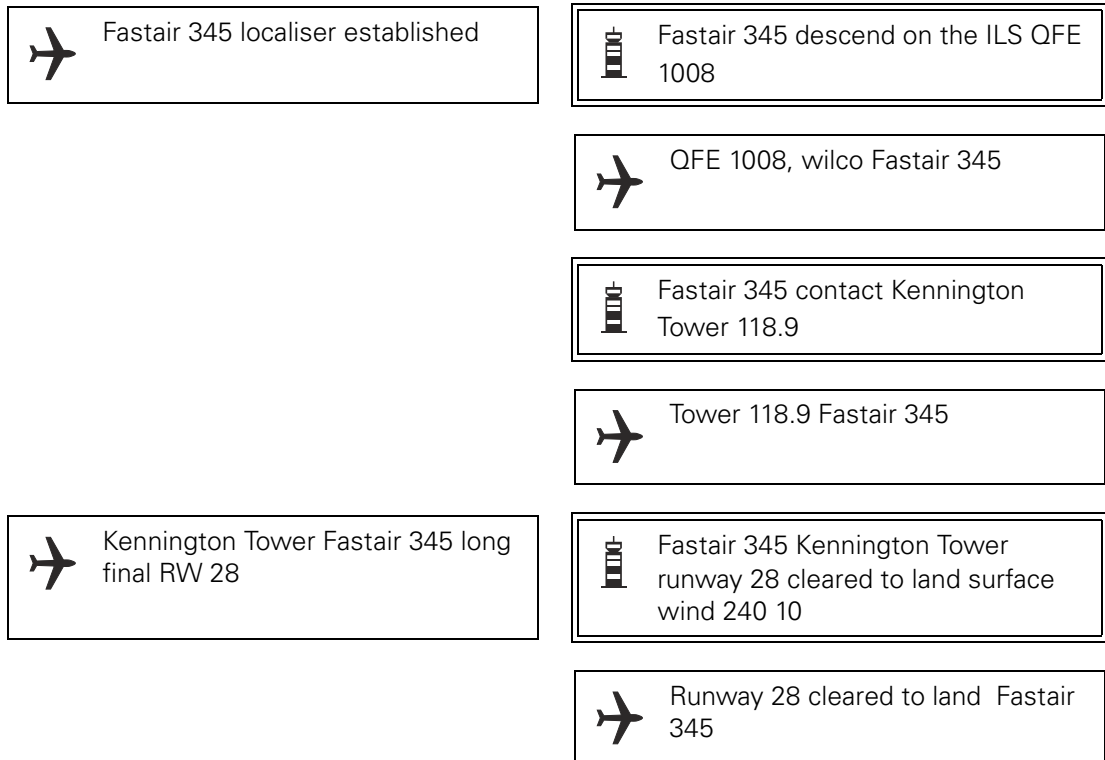


**Figure 22** IFR – Intercepting the Localiser

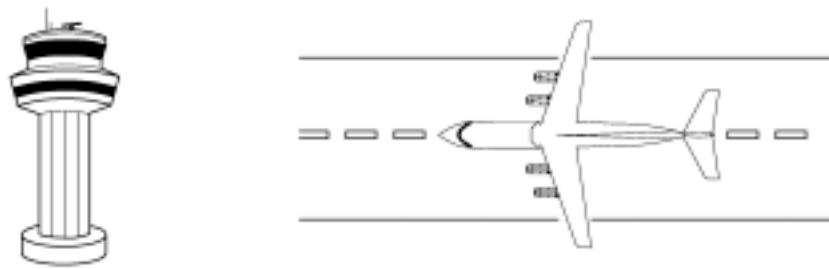





**Figure 23** IFR – Landing Clearance



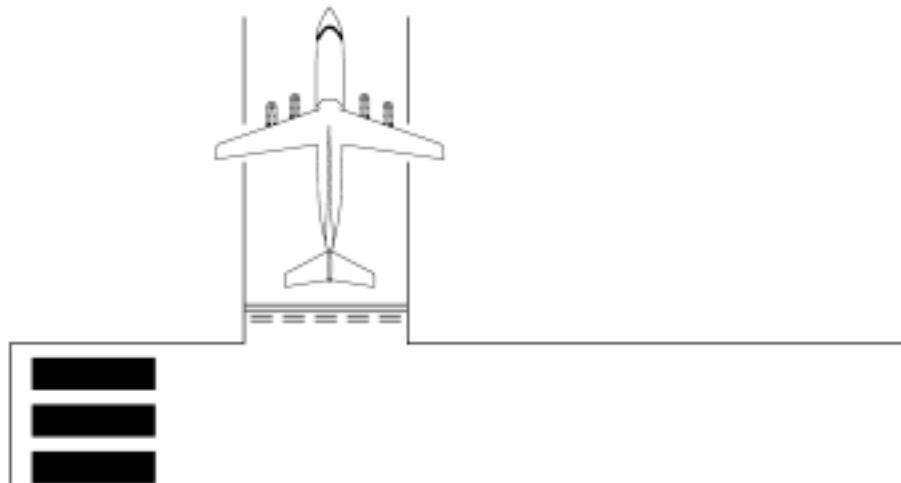
**NOTE:** Surface wind: 'Degrees' and 'Knots' may be omitted.




**Figure 24** IFR – Vacate the Runway

 Fastair 345 *vacate* convenient right

 Vacate right Fastair 345



**Figure 25** IFR – Runway Vacated

 Fastair 345 runway *vacated*

**NOTE:** VACATE runway and *not* CLEAR runway.

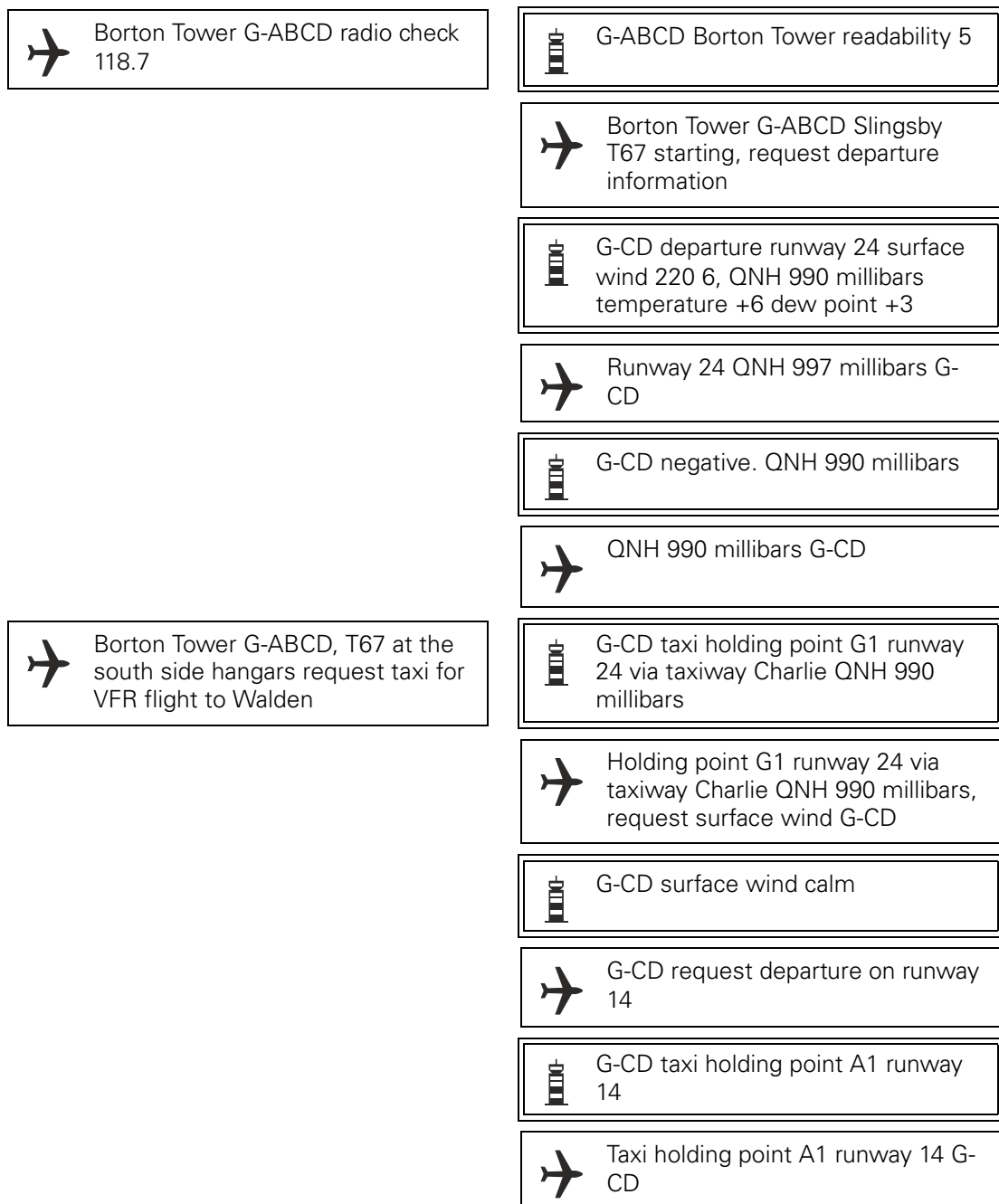
1.3 **A VFR/IFR Flight**

1.3.1 This particular example is aimed at the pilot flying outside controlled airspace under services provided by the military in the UK (Westbury) to show the slight differences that exist from civil ATS as portrayed in previous chapters.

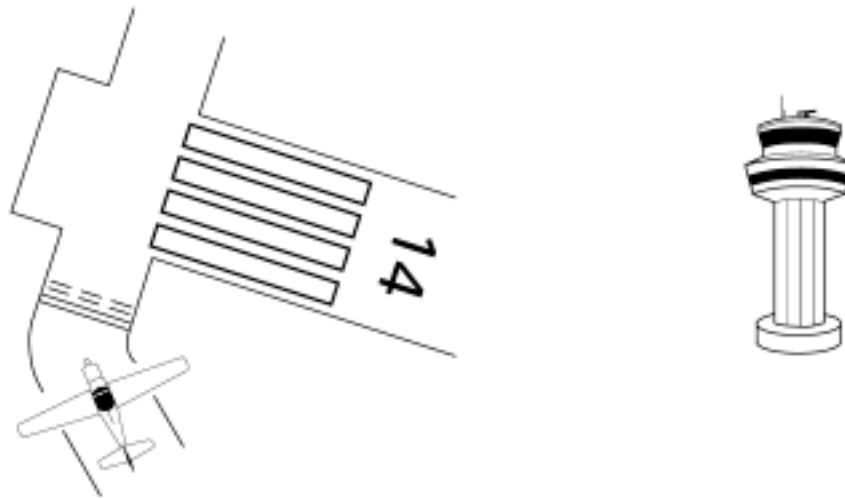
1.3.2 **Engine Start and Departure Information**








**Figure 26** VFR – Start up and Taxi



### 1.3.3 Pre-departure and Take-off



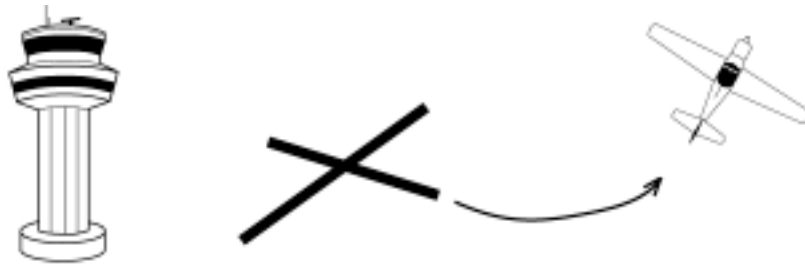
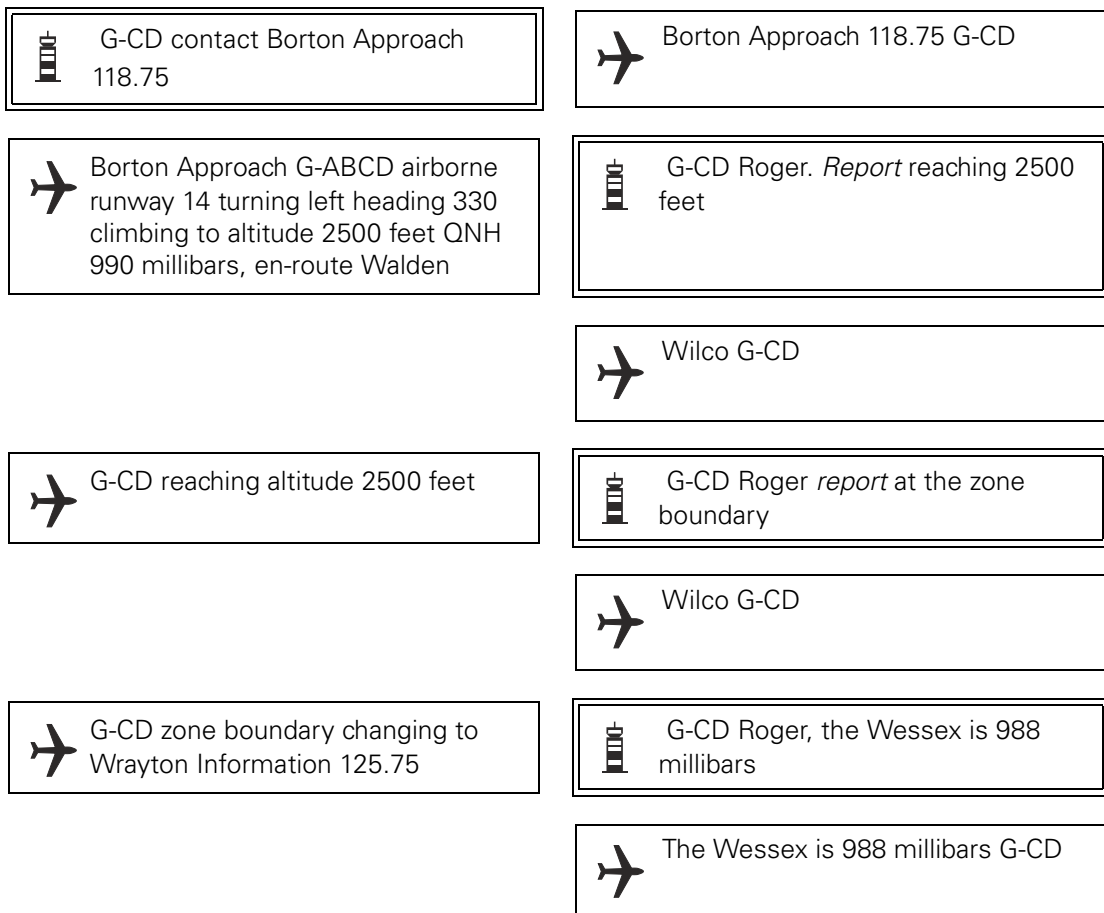
**Figure 27** VFR – Departure Instructions and Take-off Clearance

 G-CD ready for <i>departure</i> request left turnout heading 330	 G-CD, left turn <i>approved</i> . After departure climb not above altitude 2500 feet until reaching the zone boundary
 Left turn approved. Not above altitude 2500 feet until zone boundary G-CD	 G-CD runway 14 cleared for take-off surface wind 220 4
 Runway 14 cleared for take-off G- CD	

**NOTES:**

- 1 DEPARTURE used not TAKE-OFF.
- 2 APPROVED used not CLEARED.
- 3 Full readback of departure clearance.
- 4 Runway identified as in this case it is not the runway in use.
- 5 Readback of take-off clearance.

## 1.3.4 Post Departure Flight

**Figure 28** VFR – Departure Report**NOTES:**











- 1 REPORT introduced.
- 2 CHANGING TO announces intention to change frequency.
- 3 Transmission of WESSEX Regional Pressure Setting is limited to regional name and pressure.



1.3.5 En-route Flight

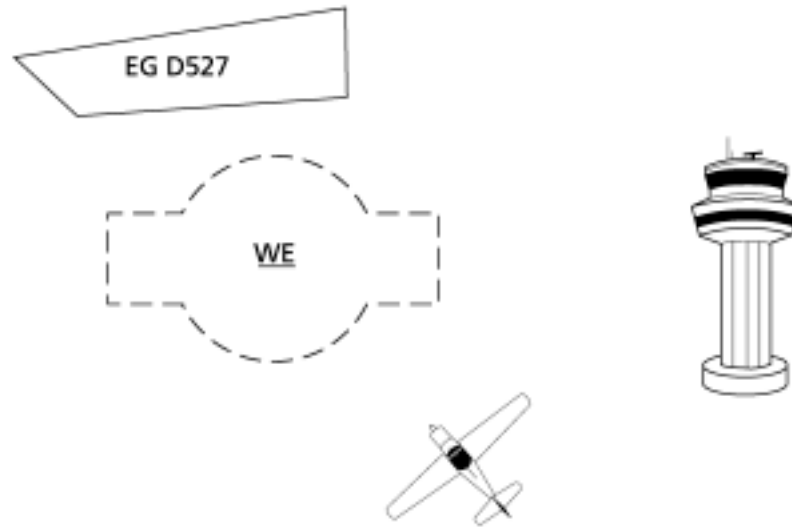


**Figure 29** VFR – FIS Request

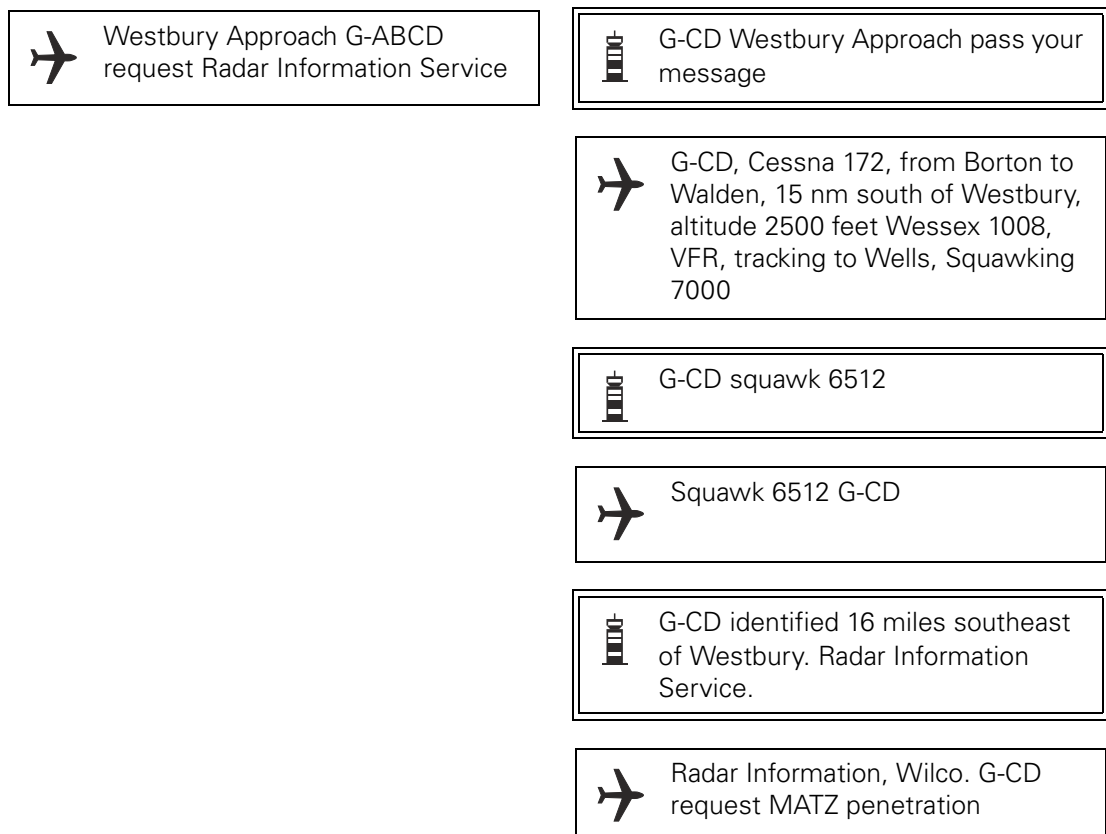
 Wrayton Information G-ABCD request Flight Information Service	 G-ABCD Wrayton Information pass your message
	 Wrayton G-CD Cessna 172, from Borton to Walden, 15 nm south of Wrayton, altitude 2500 feet Wessex 1008, VFR, tracking to Walden
	 G-CD Roger. Flight Information Service
	 Flight Information G-CD
 Wrayton G-CD request VHF frequency for Westbury	 G-CD Westbury Approach 119.7
	 Wrayton Information G-CD descending due weather. Changing to Westbury Approach for Radar Information Service
	 G-CD the Wessex is 988 millibars
	 Wessex 988 millibars G-CD

### 1.3.6 Flight Receiving Lower Airspace Radar Service and MATZ Penetration Service

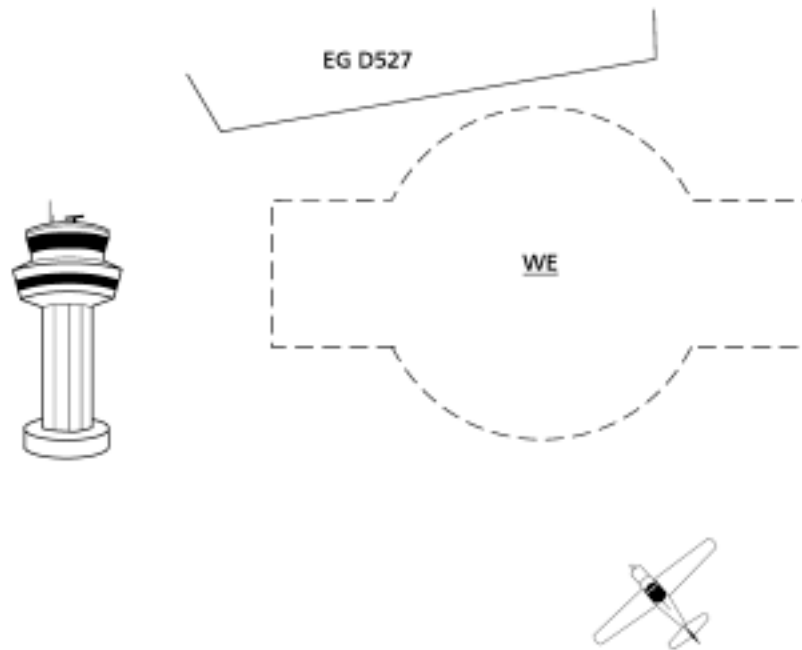
**NOTE:** Westbury is a military unit.



**Figure 30** VFR – LARS RIS Request

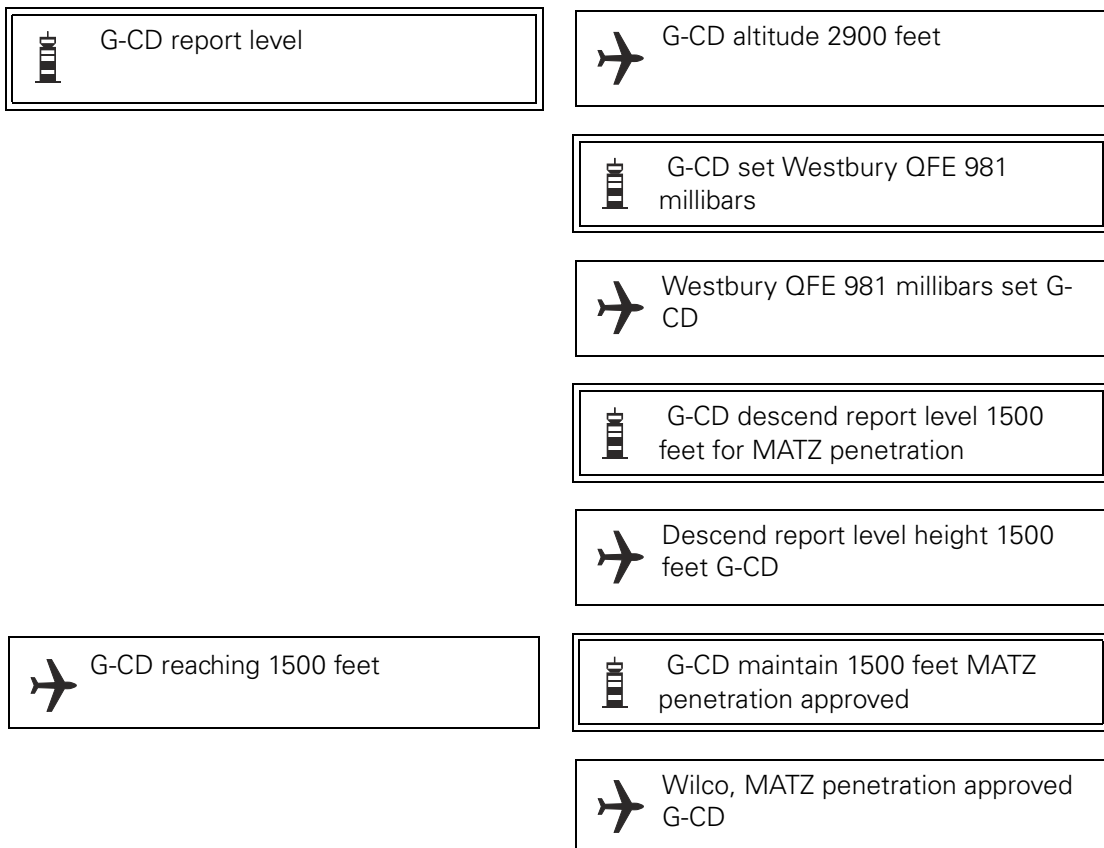


**NOTE:** Details of LARS and MATZ Penetration Service can be found in the UK AIP, AICs and Temporary Supplements.

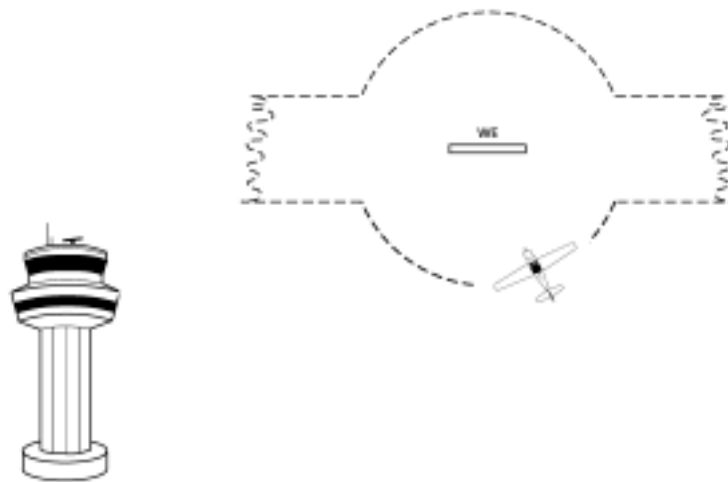


**Figure 31** VFR – MATZ Penetration











I



**NOTE:** Military controllers do not apply the conventions relating to the use of altitude/height clearances as described at Chapter 3, paragraph 1.2.3 b).



**Figure 32** VFR – Join Request

 G-CD entering MATZ limited warning of traffic from ahead as you approach my radar overhead	 G-CD Roger. Request join for one visual circuit
 G-CD Roger. Standby	
 G-CD one visual circuit approved maintain 1500 feet to overhead. Do you have the field in sight?	
 Maintain 1500 feet to overhead. G-CD has the field in sight	
 G-CD roger. Runway 27 right hand circuit height 1000 feet QFE 981 millibars	
 Runway 27 right hand circuit height 1000 feet QFE 981 millibars G-CD	
 G-CD what is your POB	
 1 POB G-CD	
 G-CD contact Westbury Tower 132.85, radar service terminated	

I

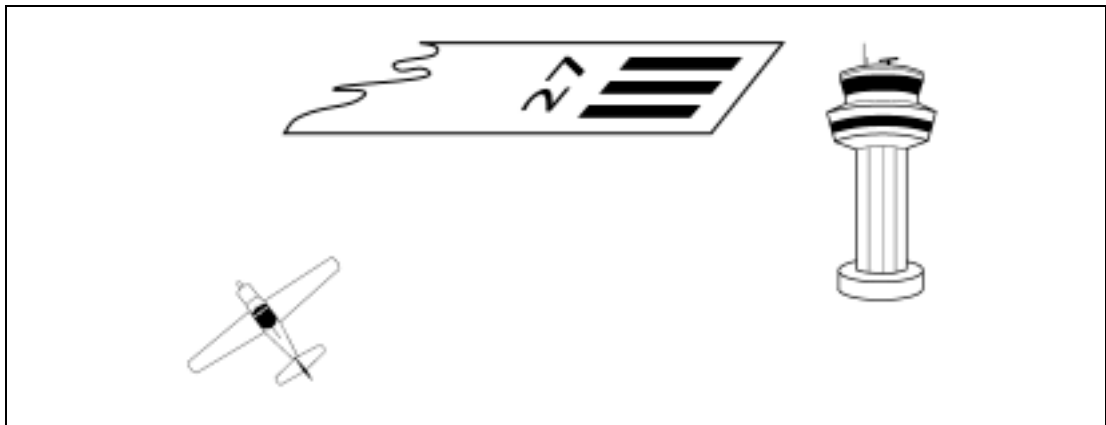


Westbury Tower 132.85 G-CD


**NOTES:**


- 1 The question of landing fees etc. is not addressed in this scenario.
- 2 Circuit direction is only given when circuit is not left-hand.
- 3 Military units employ QFE in the circuit area, the instrument pattern and for MATZ penetration.
- 4 POB – Total number of People on Board.


1.4 **Flight in the Military Visual Circuit**




**Figure 33** VFR – Circuit Join

 Westbury Tower G-ABCD 2 miles southeast height 1500 feet QFE 981 millibars to join for one visual circuit

 G-CD Westbury Tower join overhead at 1500 feet for runway 27 right hand QFE 981 millibars circuit clear

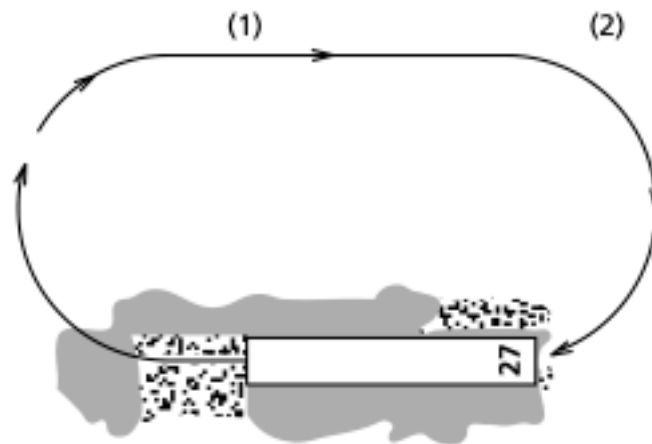
 Join overhead 1500 feet runway 27 right hand QFE 981 millibars G-CD

 G-CD overhead 1500 feet

 G-CD report downwind at 1000 feet one fast jet joining base leg to land

 Wilco G-CD

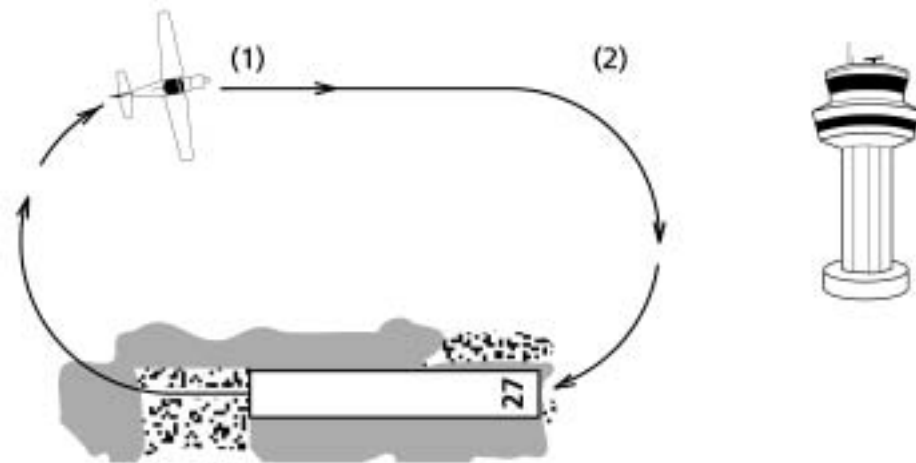
|



**Figure 34** Military Visual Circuit Pattern


**NOTES:**


- 1 Downwind report is made abeam upwind end of runway. Aircraft intentions are stated here.
- 2 'Final' call is made *just before turning base leg*.
- 3 Military (jet) circuits tend to be relatively tight and are more oval-shaped.
- 4 Military use 'two in', 'three in' etc. for number of aircraft present in the visual circuit.




**Figure 35** VFR – Downwind, DACS Request


(1)

 G-CD downwind 1000 feet request touch and go then depart to the northwest. Request Danger Area Crossing Service of EGD512

 G-CD surface wind 250 5 one ahead to land. DACS request copied

(2)

 G-CD final gear down

 G-CD go around 500 feet deadside one on remaining

 Go around 500 feet deadside G-CD


**NOTES:**


- 1 Surface wind is passed at downwind position.
- 2 An aircraft with retractable undercarriage will be expected to call 'gear down' or three greens with the final call.
- 3 Military use 'Roll' for 'Touch and Go'.
- 4 'Go Around' see Chapter 4, paragraph 1.10.4.
- 5 Military use 'Overshoot' for 'Low Approach'.






**Figure 36** IFR – Departure Instructions (ii)

 G-CD at upwind end of runway turn right heading 290 climb to 2000 feet QFE 981 millibars

 Upwind end of runway right heading 290 climb to height 2000 feet QFE 981 millibars G-CD



**Figure 37** IFR – Departure Report (ii)

 G-CD heading 290 climbing to height 2000 feet

 G-CD contact Westbury Approach 119.7

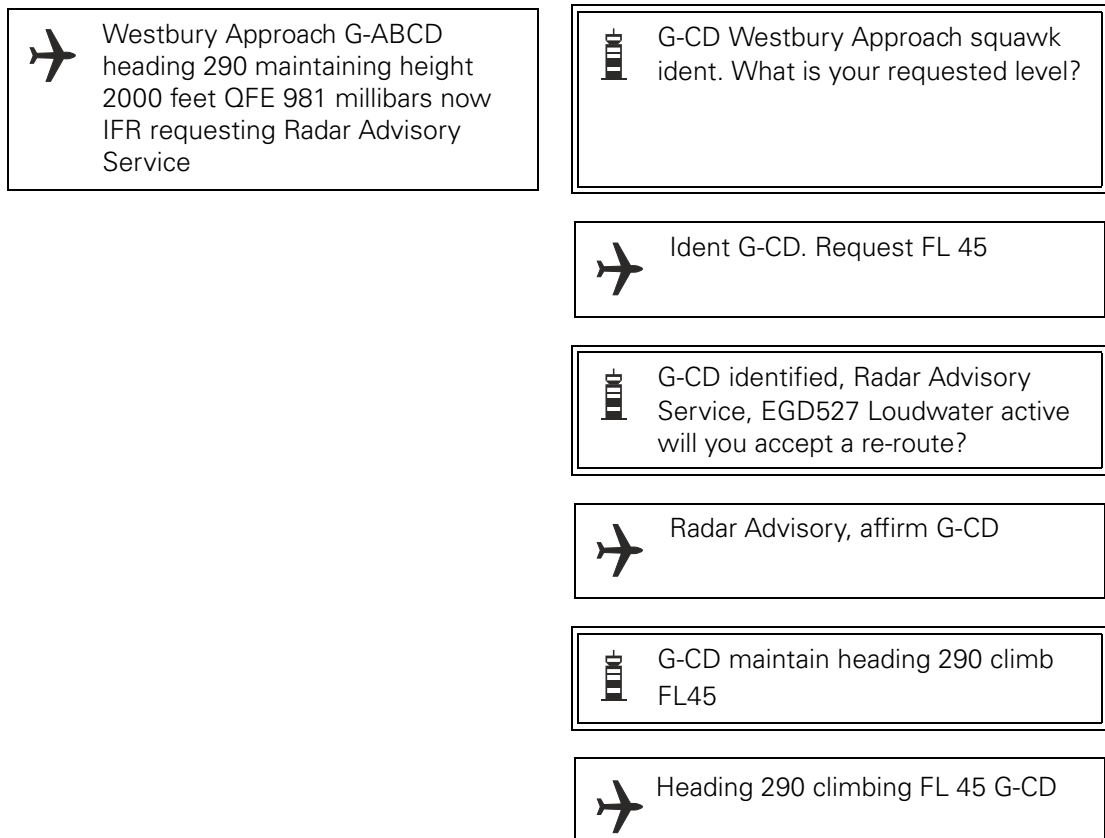
 Westbury Approach 119.7 G-CD

**NOTE:** Full readback of clearance and frequency change.

## 1.5 Flight Receiving Lower Airspace Radar Service (LARS) and Danger Area Crossing Service (DACS)

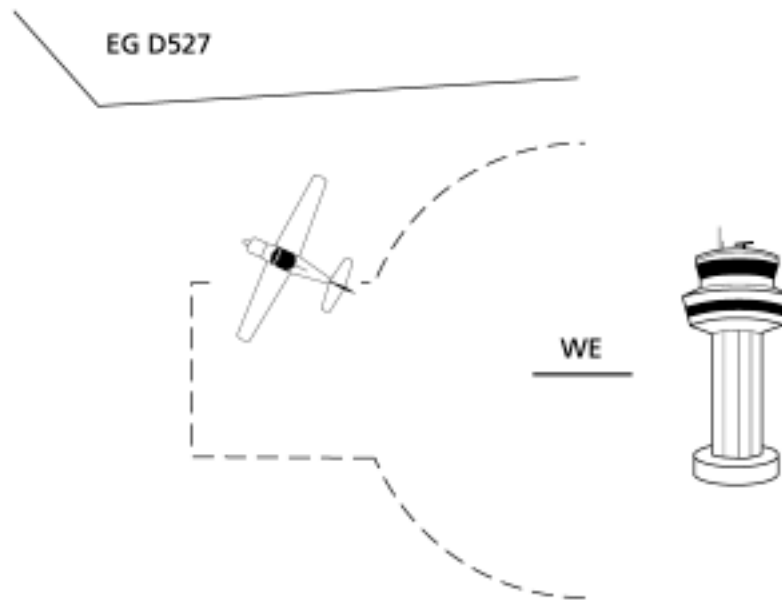


**Figure 38** VFR – Requesting RAS








### NOTES:

- 1 AFFIRM used.
- 2 Military controllers use 'MAINTAIN' heading.



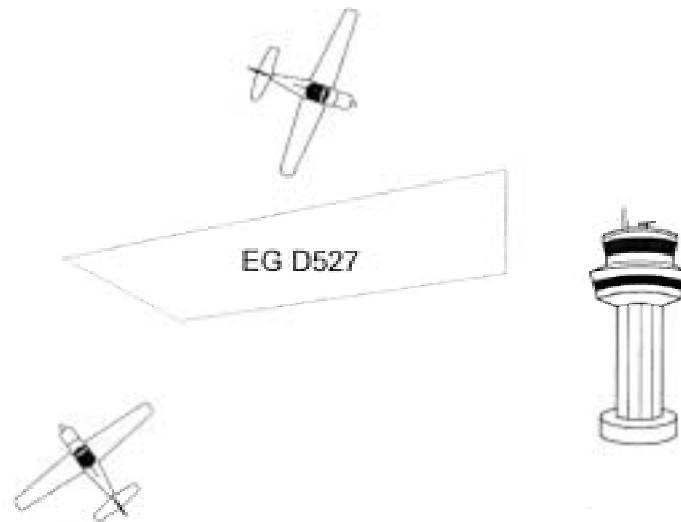
**Figure 39** VFR – Report Leaving a MATZ

 G-CD leaving MATZ	 G-CD
	 G-CD reaching FL 45
	 G-CD Roger I will be turning you right in 7 miles to regain track
	 G-CD

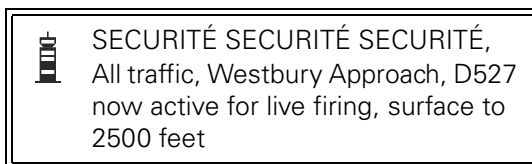
**NOTE:** Report leaving a MATZ.

## 1.6 Military Safety Broadcast - Sécurité

Military ground stations may commence a broadcast message with 'SECURITÉ SECURITÉ SECURITÉ' (SEC-URI-TAY spoken three times) to inform all traffic that the message contains information affecting safety, but not an emergency situation. Aircraft acknowledgement is not required, however aircraft may contact the ground station to obtain further details.



**Figure 40** Sécurité Broadcast





## 1.7 Callsign Prefix - TYRO

- 1.7.1 Inexperienced civil pilots in communicating with a military unit or the D&D Section may consider prefixing their callsign with the codeword 'TYRO' to indicate their lack of experience.
- 1.7.2 An inexperienced pilot experiencing an emergency and communicating with a military unit or the D&D section should indicate their inexperience and may elect to use the callsign prefix TYRO. A military ground station or the D&D section receiving an emergency message may use information on pilot experience to correctly categorise the emergency and to render appropriate assistance (see also Chapter 8, Emergency Phraseology, paragraph 1.5).




**Figure 41** Callsign Prefix 'TYRO'


 <p>MAYDAY MAYDAY MAYDAY            WRAYTON CENTRE            TYRO G-ABCD            Piper Cherokee            Lost Above Cloud            Altitude 3000 feet            Heading East            No Instrument Qualification            Endurance 1 hour            3 POB</p>	 <p>G-ABCD Roger MAYDAY ...(any pertinent information)</p>
--	---

1.8 Flight Receiving Avoiding Action



**Figure 42** Avoiding Action

 G-CD avoiding action, turn left heading 230 pop-up traffic was 12 o'clock range 6 miles no height reciprocal heading


 Left heading 230 G-CD


**NOTES:**


- 1 This type of avoiding action when under Radar Advisory is given at the controller's discretion for late sighting/pop-up traffic.
- 2 An unknown traffic call as follows can be expected as follows: G-CD unknown traffic 11 o'clock 6 miles crossing left to right height unknown, if not sighted turn left heading 230.




**Figure 43** Clear of Traffic

 G-CD clear of traffic, turn right heading 340 direct for Walden

 Right heading 340. Request change to Wrayton Information 125.75 G-CD

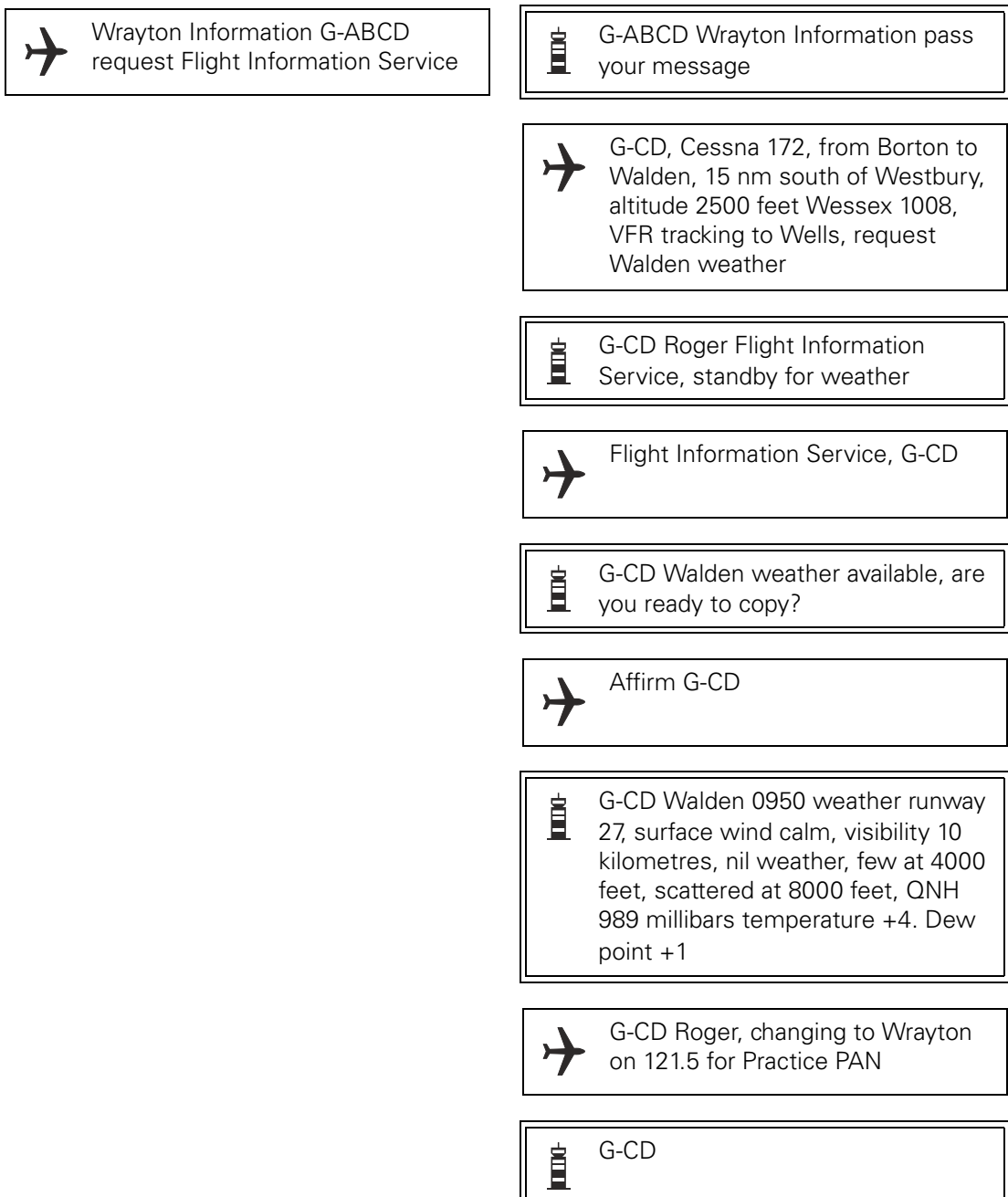
 G-CD squawk 7000 Westbury terminating service

 Squawk 7000 G-CD

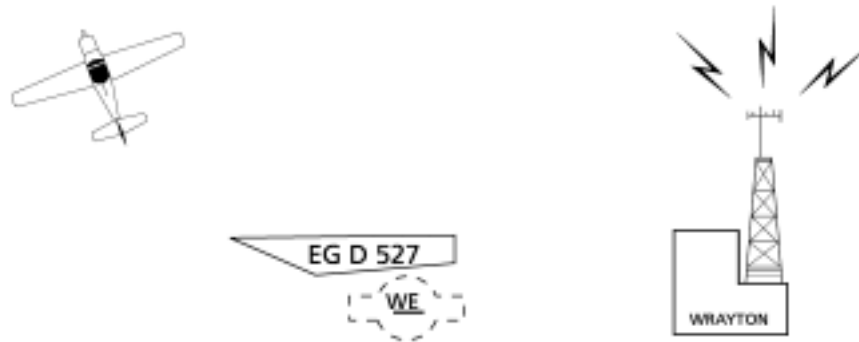
1.9 Flight Receiving En-Route Flight Information Service








**Figure 44** VFR – Enroute Reply to Pass Your Message



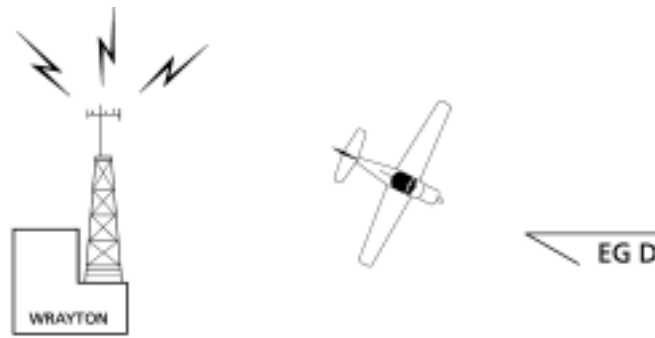
1.10 **Flight Transmitting a Practice Pan**  
(121.5 – listen out before transmitting)











**Figure 45** Practice Pan Call

 Practice Pan, Practice Pan, Practice Pan, Wrayton Centre G-ABCD	 G-ABCD this is Wrayton Centre continue with Practice Pan
<p>I</p>	 Wrayton Centre G-ABCD, Slingsby T67, simulating rough running engine, request diversion to nearest aerodrome, 20 miles northwest of Westbury, FL 45, turning right heading 140, IMC rating, one person on board squawking 7000 with Charlie
	 G-ABCD Wrayton squawk 7301 ident
	 7301 ident G-ABCD



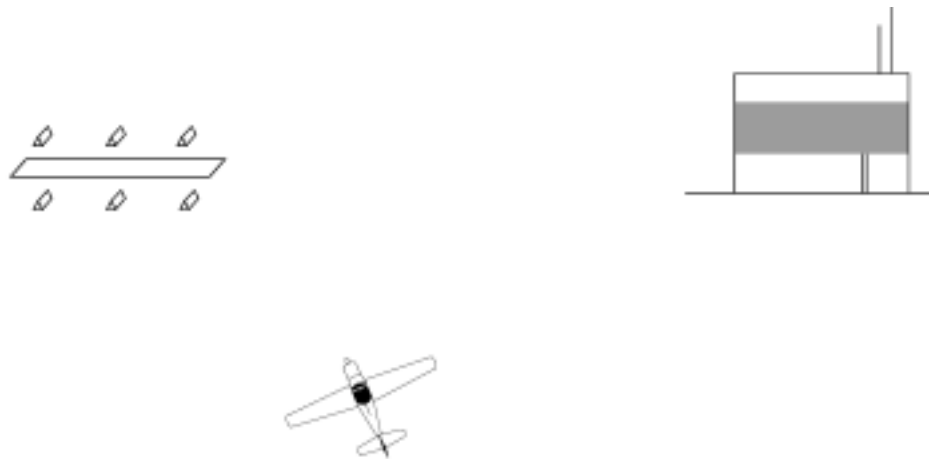


**Figure 46** VFR – Practice PAN – Radar Identification












- |  |  |
|--|--|
|  G-ABCD identified 17 miles northwest of Westbury, turn right heading 160 for Westbury for landing runway 09 surface wind 270 3 knots |  Heading 160 for approach to runway 09 at Westbury G-ABCD |
|  G-ABCD are you ready for Westbury weather, 13 miles northwest of Westbury  |  |
|  Wrayton Westbury weather not required cancelling Practice Pan G-ABCD   |  |
|  G-ABCD Roger. Practice Pan cancelled   |  |
|  G-ABCD changing to Walden 135.25   |  |
|  G-ABCD squawk 7000   |  |
|  7000 G-ABCD  |  |

**NOTE:** Use of the VHF International Emergency Service is detailed in the UK AIP and AICs and Chapter 8, Emergency Phraseology.

1.11 Arrival Flight (Aerodrome FIS)



**Figure 47** VFR – AFIS Arrival

 Walden Information G-ABCD	 G-ABCD Walden Information pass your message
	 G-ABCD T67, 6 miles southeast descending to height 1000 feet for landing
	 G-CD runway 27 QFE 986 millibars 3 aircraft in circuit
	 Runway 27 QFE 986 millibars G-CD
 G-CD joining leftbase	 G-CD
	 G-CD final
	 G-CD runway occupied with a PA28, surface wind 260 6
	 G-CD runway now vacated, land at your discretion, surface wind 270 10
	 G-CD roger landing



G-CD



G-CD runway vacated

**NOTES:**

- 1 Joining **Information** is provided by FISOs and the pilot should position accordingly.
- 2 Joining **Instructions** are only issued where an **ATC** service is provided.
- 3 When taking off or landing, the pilot should state his intention when options are available e.g. landing/going around, taking off/holding position.

## Appendix 1 UK differences to ICAO Radiotelephony Procedures

- 1 ICAO sets out standard international phraseology for communications between air traffic services and pilots in several documents including Annex 10 Volume 2 (Communications Procedures) to the Convention on International Civil Aviation and ICAO PANS-ATM (Procedures for Air Navigation Services – Air Traffic Management) Doc. 4444.
- 2 Where the ICAO standard phraseology may be misunderstood, or has weaknesses in the UK environment, different phraseology has been specified for use (and notified to ICAO). In the UK, air traffic service units and pilots are expected to comply with the phraseology and procedures described in main text of this document.
- 3 When communicating with air traffic service units in other States pilots should use phraseology and procedures set out by ICAO (subject to any differences notified by that State).
- 4 Significant differences between the ICAO standard phraseology and that specified for use in CAP413 are described in the table (below).

**Table 1**

Details of ICAO/UK Difference	Reason/Remarks
Phraseology <b>FLIGHT LEVEL ONE ZERO ZERO</b> (ICAO) is not used in UK. In the UK flight levels ending in hundreds are transmitted as <b>HUNDRED e.g. FLIGHT LEVEL ONE HUNDRED.</b>	To avoid potential confusion with adjacent flight levels and misidentification of cleared levels e.g. FLIGHT LEVEL ONE ZERO ZERO with FLIGHT LEVEL ONE ONE ZERO.
In the UK, the name of either the aircraft manufacturer, or name of the aircraft model, <b>or name of the aircraft category (e.g. helicopter or gyrocopter)</b> may be used as a prefix to the callsign.	To aid recognition by the ground station and/or other aircraft that the aircraft transmitting is of a particular category and may manoeuvre differently or require special handling.
In the UK <b>CONTACT</b> shall have the meaning <b>“Establish communications with...(your details have been passed)”</b> .	This shortens a pilot’s first call on the next ATS unit/frequency, as he/she knows he/she does not have to pass full details.
In the UK the additional term - <b>FREECALL</b> shall have the meaning <b>“CALL (unit) (your details have not been passed)”</b> .	This informs the pilot he/she will have to pass full details to the next ATS unit/frequency on first contact.
The phrase <b>GO AHEAD</b> (ICAO) is not used in the UK. In the UK the term <b>PASS YOUR MESSAGE</b> is used.	<b>GO AHEAD</b> is not used on safety grounds (e.g. to reduce runway incursions) where some pilots/drivers might confuse <b>GO AHEAD</b> with <b>PROCEED</b> .
<b>RECLEARED</b> (ICAO) is not used in UK.	The direction of vertical movement, provided by <b>CLIMB</b> and <b>DESCEND</b> , acts as a check in some circumstances when a pilot misinterprets a call not directed at him/her.
The following method of acknowledging receipt is not used in UK. <b>‘The callsign of the aircraft followed if necessary by callsign of the aeronautical station’</b> (ICAO). <b>(CALLSIGN) ROGER</b> is used in the UK.	The UK procedure is in accordance with the examples in ICAO Doc 9432 (1990) Manual of Radiotelephony, which are different to those described in ICAO Annex 10 Aeronautical Telecommunications.

**Table 1**

<p><b>RVSM Phraseology</b> In the UK, pilots are not required to report non-approved (RVSM) status in all requests for level changes and in all read-backs of level changes (ICAO).</p>	<p>This procedure is considered too cumbersome and not required as the controller has a mechanism for the status of the aircraft to be reflected.</p>
<p><b>NEGATIVE I SAY AGAIN</b> (ICAO) is not used in UK. In the UK, if a readback is incorrect, the aeronautical station shall transmit the word <b>NEGATIVE</b> followed by the correct version.</p>	<p>The phrase <b>I SAY AGAIN</b> is considered superfluous in this case.</p>
<p>The ICAO phraseology for conditional line-up clearance <b>FASTAIR 345, BEHIND THE DC9 ON SHORT FINAL, LINE UP BEHIND</b> (ICAO) is not used. In the UK the phrase <b>FASTAIR 345 AFTER THE LANDING DC9 LINE UP</b> is used.</p>	<p><b>AFTER</b> is used instead of <b>BEHIND</b> to describe more clearly 'sequential following' rather than 'further back'. The reiteration of the condition at the end of the phrase is considered to reduce the clarity of the instruction.</p>
<p>In the UK the term <b>HOLDING POSITION</b> (ICAO) is not used. In the UK the term <b>HOLDING POSITION</b> (ICAO) is replaced by the term <b>HOLDING POINT</b>.</p>	<p>For safety reasons, due to potential confusion with <b>HOLD POSITION</b> and <b>TAXI INTO POSITION AND HOLD*</b> (*used in some states, which allows the aircraft to enter the active runway).</p>
<p>In the UK an additional phrase, <b>LAND AFTER THE (Aircraft Type)</b> is used.</p>	<p>This phrase may be used under certain conditions and indicates that a preceding aircraft is not clear of the runway.</p>
<p>In the UK, additional phrases, <b>LAND AT YOUR DISCRETION</b> and <b>TAKE-OFF AT YOUR DISCRETION</b> are used.</p>	<p>These phrases may be used under certain conditions and indicate that a landing clearance or a take-off clearance cannot be issued and any landing or take-off is to be conducted at the pilot's discretion.</p>
<p>The following method of ending conversations is not used in UK. <b>'A radiotelephone conversation shall be terminated by the receiving station using its own callsign'</b> (ICAO). In the UK the word <b>OUT</b> is used to indicate that the transmission has ended and no response is expected.</p>	<p>When there little possibility of confusion or misunderstanding, the word <b>OUT</b> is normally omitted.</p>
<p>Radiotelephony Reply Procedure In the UK under certain circumstances the answering ground station may omit its callsign.</p>	<p>Omitting the ground station callsign may reduce RTF congestion and therefore improve safety standards at busy ATC units.</p>
<p>Inter pilot air-to-air communication on 123.45 MHz Air-to-air communications on frequency 123.45 MHz (ICAO) are not permitted in UK.</p>	<p>Frequency 123.45 MHz is assigned for discrete ATC purposes within UK.</p>
<p>Helicopter Phraseology Additional radiotelephony terms for helicopter operations are defined for use in the UK.</p>	<p>To reduce the possibility of misunderstanding, several additional terms pertaining to rotary-wing operations are defined for use in the UK.</p>
<p>Listening Watch on 121.5 MHz ICAO Requirements for Aeronautical Station Listening Watch on VHF emergency channel 121.5 MHz are not applied in UK.</p>	<p>VHF emergency channel frequency 121.5 MHz is not routinely monitored at civil aerodromes, however, it is monitored <i>H24</i> at Area Control Centres with coverage over most of UK above 3000' amsl.</p>
<p>Atmospheric Pressure The term <b>HECTOPASCAL</b> is not used in the UK.</p>	<p>When describing atmospheric pressure, the term <b>MILLIBAR</b> (Mb) is used in the UK in place of <b>HECTOPASCAL</b> (hPa) (One Millibar being equal to one Hectopascal).</p>

## Bibliography

ICAO Annex 10 Volume 2 Communication Procedures

ICAO Document No. 4444 Procedures for Air Navigation Services - Air Traffic Management (PANS-ATM)

ICAO Document No. 8400 Procedures for Air Navigation Services – ICAO Abbreviations and Codes (PANS-ABC)

CAP 32 UK Aeronautical Information Publication (AIP) (*All 'ENR' references are contained herein.*)

CAP 493 Manual of Air Traffic Services (MATS Part 1)

CAP 410 Manual of Flight Information Services (*Consists of two volumes, Part A and Part B*)

CAP 452 Aeronautical Radio Station Operator's Guide

Many CAA Publications are available from the CAA website at [www.caa.co.uk](http://www.caa.co.uk).

# Index

## Numerics

8.33 kHz Phraseology Chapter 9, Page 3

## A

Abandon take-off Chapter 4, Page 7

Abbreviations Chapter 1, Page 4

ACAS/TCAS Phraseology Chapter 5, Page 6

Acknowledgement of Receipt Chapter 2, Page 10

Aerodrome Air/Ground Communication Service Chapter 2, Page 7

Aerodrome Control Service Chapter 1, Page 1

Aerodrome Flight Information Service (AFIS) Chapter 1, Page 1

Aerodrome Traffic Circuit Chapter 4, Page 8

Aerodrome Traffic Zone Chapter 1, Page 1,  
Chapter 4, Page 14

Aeronautical stations Chapter 2, Page 7

Air traffic control service Chapter 2, Page 7

Air/Ground Station Identification Chapter 4, Page 25

Airborne Collision Avoidance System Chapter 1, Page 1

Aircraft Operating Agency Messages Chapter 9, Page 2

Aircraft radio faults Chapter 2, Page 15

AIRPROX Chapter 1, Page 1,  
Chapter 1, Page 5,  
Chapter 9, Page 1

Airway Chapter 1, Page 2

Altitude Chapter 1, Page 2

Approach Control Service Phraseology Chapter 6, Page 1

Approach control unit Chapter 6, Page 2,  
Chapter 6, Page 6

Area Control Service Phraseology Chapter 7, Page 1

ATC instructions Chapter 3, Page 3

ATC route clearance Chapter 2, Page 11,  
Chapter 6, Page 1

ATIS	Chapter 1, Page 5, Chapter 4, Page 1, Chapter 4, Page 4, Chapter 4, Page 8, Chapter 4, Page 38, Chapter 6, Page 6
ATZ	Chapter 1, Page 5, Chapter 4, Page 1, Chapter 4, Page 14, Chapter 4, Page 25
Avoiding Action Phraseology	Chapter 5, Page 5
<b>C</b>	
Callsign Prefix - TYRO	Chapter 10, Page 32
Callsigns for Aeronautical Stations	Chapter 2, Page 7
Callsigns for Aircraft	Chapter 2, Page 8
Cancel an IFR flight plan	Chapter 3, Page 5
Categories of Message	Chapter 2, Page 16
Clearance Issue	Chapter 2, Page 11
Clearance limit	Chapter 4, Page 2
Communication failure	Chapter 2, Page 13
Communications and Loss of Communications	Chapter 5, Page 7
Conditional clearances	Chapter 4, Page 6
Continuation of Communications	Chapter 2, Page 8
Continuous listening watch	Chapter 4, Page 22
Controlled airspace	Chapter 1, Page 2, Chapter 2, Page 12, Chapter 6, Page 2, Chapter 7, Page 2
Corrections and Repetitions	Chapter 2, Page 10
CPDLC	Chapter 1, Page 5
Cross a Runway	Chapter 4, Page 23
<b>D</b>	
D&D Sections	Chapter 8, Page 1
DAAIS	Chapter 1, Page 5, Chapter 5, Page 8
DACS	Chapter 1, Page 5
Danger Area Activity Information Service (DAAIS)	Chapter 5, Page 7, Chapter 5, Page 8
Danger Area Crossing Service (DACCS)	Chapter 5, Page 7, Chapter 10, Page 29



Definitions	Chapter 1, Page 1
Departure Information and Engine Starting Procedures	Chapter 4, Page 1
Descent clearance	Chapter 6, Page 2
Designated Positions in the Traffic Circuit	Chapter 3, Page 7
Direction Finding (DF)	Chapter 6, Page 10
Distress and Urgency Communication Procedures	Chapter 8, Page 1
<b>E</b>	
Emergency Message	Chapter 8, Page 3
Emergency Service	Chapter 8, Page 1
Essential Aerodrome Information	Chapter 4, Page 12
<b>F</b>	
Final Approach and Landing	Chapter 4, Page 10
Flight Information Service (FIS)	Chapter 1, Page 2, Chapter 2, Page 7, Chapter 4, Page 14, Chapter 10, Page 34
Flight Plans	Chapter 3, Page 4
Flight Receiving Avoiding Action	Chapter 10, Page 33
Flight Receiving Lower Airspace Radar Service	Chapter 10, Page 21
Flights Crossing Airways	Chapter 7, Page 3
Flights Holding En-Route	Chapter 7, Page 3
Flights Joining Airways	Chapter 7, Page 2
Flights Leaving Airways	Chapter 7, Page 2
<b>G</b>	
Glidepath	Chapter 6, Page 7
Go Around	Chapter 4, Page 11
<b>H</b>	
Helicopter Callsigns	Chapter 4, Page 18
Helicopter Phraseology	Chapter 4, Page 18
Hold en-route	Chapter 7, Page 3
Holding pattern	Chapter 6, Page 15
Holding point	Chapter 1, Page 3, Chapter 4, Page 2, Chapter 4, Page 4
Hours of Service and Communications Watch	Chapter 2, Page 15

**I**

IFR Arrivals	Chapter 6, Page 2
IFR Departures	Chapter 6, Page 1
ILS	Chapter 1, Page 6, Chapter 6, Page 7
Imposition of Silence	Chapter 8, Page 5
Instrument approach procedures	Chapter 6, Page 15
Instrument Departures	Chapter 6, Page 1
Interceptions by Military Aircraft	Chapter 9, Page 2

**L**

Landing Altimeter Setting (QNE)	Chapter 6, Page 18
Letters	Chapter 2, Page 2
Level Instructions	Chapter 3, Page 1
Listening watch	Chapter 2, Page 16
Localiser	Chapter 6, Page 7
Lower Airspace Radar Service (LARS)	Chapter 6, Page 24, Chapter 10, Page 29

**M**

MATZ	Chapter 1, Page 7, Chapter 6, Page 24
MATZ Penetration Service	Chapter 6, Page 24, Chapter 10, Page 21
MAYDAY	Chapter 8, Page 1, Chapter 8, Page 3
Meteorological aerodrome reports	Chapter 4, Page 35
Meteorological Conditions	Chapter 4, Page 35
Microwave	Chapter 6, Page 7
Microwave Approach	Chapter 1, Page 3
Military Safety Broadcast - Sécurité	Chapter 10, Page 31
Military Visual Circuit	Chapter 10, Page 25
Millibars	Chapter 3, Page 2
Missed Approach	Chapter 4, Page 11
Missed Approach Procedure	Chapter 1, Page 3
MLS	Chapter 1, Page 7, Chapter 6, Page 7
Movement Instructions	Chapter 4, Page 22
Movement of vehicles	Chapter 4, Page 22

**N**

NDB(L) and VOR Procedures	Chapter 6, Page 15
Numbers	Chapter 2, Page 3

**O**

Offshore Communication Service	Chapter 4, Page 28
Offshore Phraseology	Chapter 4, Page 29
Offshore Station Identification	Chapter 4, Page 29
Oil Pollution Reporting	Chapter 9, Page 2

**P**

PAN PAN	Chapter 8, Page 1, Chapter 8, Page 3
PAR Approach	Chapter 6, Page 19
Pass Your Message	Chapter 3, Page 6
Position Reporting	Chapter 3, Page 4, Chapter 7, Page 1
Practice Pan	Chapter 10, Page 35
Pre-Departure Manoeuvring	Chapter 4, Page 4
Pushback and Powerback	Chapter 4, Page 2

**Q**

QDM	Chapter 1, Page 7, Chapter 6, Page 10
QDR	Chapter 1, Page 7, Chapter 6, Page 10
QFE	Chapter 1, Page 7, Chapter 4, Page 29, Chapter 6, Page 16, Chapter 6, Page 18, Chapter 10, Page 24
QNE	Chapter 1, Page 7, Chapter 6, Page 18
QNH	Chapter 1, Page 7, Chapter 3, Page 1, Chapter 4, Page 1, Chapter 4, Page 4, Chapter 6, Page 17
QTE	Chapter 1, Page 7, Chapter 6, Page 10

**R**

Radar Identification	Chapter 1, Page 3
Radar Identification of Aircraft	Chapter 5, Page 1
Radar service	Chapter 5, Page 1, Chapter 5, Page 4
Radar Vectoring	Chapter 1, Page 3, Chapter 5, Page 4
Radio Procedures – Practice Emergencies	Chapter 8, Page 4
Read Back Requirements	Chapter 2, Page 11
Readability Scale	Chapter 2, Page 15
Reduced Vertical Separation Minimum	Chapter 7, Page 4
Relayed Emergency Message	Chapter 8, Page 5
Runway Surface Conditions	Chapter 4, Page 36
Runway Vacating and Communicating After Landing	Chapter 4, Page 12
Runway Visual Range	Chapter 1, Page 3
Runway Visual Range (RVR)/Visibility/Absolute Minimum	Chapter 4, Page 36
RVR	Chapter 1, Page 8, Chapter 4, Page 36
RVSM	Chapter 7, Page 4

**S**

SAFETYCOM	Chapter 1, Page 4, Chapter 4, Page 32
Secondary Surveillance Radar Phraseology	Chapter 5, Page 2
Securité	Chapter 10, Page 31
Special Purpose Codes	Chapter 8, Page 2
Special VFR	Chapter 1, Page 4, Chapter 6, Page 2, Chapter 6, Page 7
Special VFR clearances	Chapter 6, Page 7
Speechless Code	Chapter 8, Page 4
SRA	Chapter 1, Page 8, Chapter 6, Page 16, Chapter 6, Page 17
SSR	Chapter 1, Page 8
Standard Overhead Join	Chapter 4, Page 32, Chapter 4, Page 34
Standard Words and Phrases	Chapter 2, Page 5
States of Emergency	Chapter 8, Page 1
Straight-in approach	Chapter 4, Page 8
Surveillance Radar Approach (SRA)	Chapter 6, Page 16

**T**

Take-off	Chapter 2, Page 11, Chapter 4, Page 1, Chapter 4, Page 4
Take-off clearance	Chapter 4, Page 5, Chapter 4, Page 6
Taxi Instructions	Chapter 4, Page 2
TCAS	Chapter 5, Page 6
Terminations of Distress Communications and of RTF Silence	Chapter 8, Page 6
Test procedures	Chapter 2, Page 14
Time	Chapter 2, Page 4
Traffic Alert and Collision Avoidance System (TCAS)	Chapter 1, Page 4
Traffic Information and Avoiding Action Phraseology	Chapter 5, Page 5
Training Fix	Chapter 8, Page 5
Transfer of communications	Chapter 2, Page 10
Transmission of Letters	Chapter 2, Page 2
Transmission of Numbers	Chapter 2, Page 3
Transmission of Time	Chapter 2, Page 4
Transmitter failure	Chapter 2, Page 14
Transmitting Blind	Chapter 2, Page 13
TYRO	Chapter 8, Page 3, Chapter 10, Page 32

**U**

Unattended Aerodrome Phraseology	Chapter 4, Page 33
Unattended Aerodromes	Chapter 4, Page 32

**V**

VDF Procedure	Chapter 6, Page 11
Vectoring to Final Approach	Chapter 6, Page 7
Vehicles Towing Aircraft	Chapter 4, Page 24
VFR Arrivals	Chapter 6, Page 6
VFR Departures	Chapter 6, Page 1
VHF Direction Finding (VDF)	Chapter 6, Page 10
VHF Emergency Service	Chapter 8, Page 1
Voice Weather Broadcast (VOLMET) UK	Chapter 4, Page 35

**W**

Wake Vortex	Chapter 9, Page 1
Wake vortex category	Chapter 2, Page 8
Wind Shear	Chapter 9, Page 1